

STANLEY®

HAND TOOLS & STORAGE RANGE 2015

MIDDLE EAST





TOOLS THAT BUILD THE WORLD

Since 1843, **STANLEY®** has been proudly offering quality and innovative tool solutions. For over a century, we have built a legacy by producing some of the most well known hand tools and storage products in the world, all to help you build a legacy of your own.

We are committed to bringing you durable and quality tools that are inventive and distinct. With superior quality, constant innovation and rigorous operational improvements, **STANLEY®** defines excellence and is trusted by professionals around the globe.

In 2013, **STANLEY®** embraced a new brand logo and identity, modernizing one of the most recognizable brands in the world. The new brand identity exemplifies STANLEY's 170-year reputation for innovation, merit and performance. With the evolution of the brand logo, we are proud to offer you even more cutting-edge products for all your job site needs. It is time to experience the power of innovation!



THE HISTORY OF STANLEY® TOOLS

1843

The Stanley Works was founded in New Britain, Connecticut by Frederick T. Stanley.



1863

Stanley introduced hammers to their line-up.



1911

Stanley began manufacturing chisels and vises.

1870

Stanley began manufacturing screwdrivers and hand planes.

1900

Rule & Level is the largest manufacturer of planes and related tools in the world.

1921

A new logo is introduced to symbolize the merger of the Stanley Rule & Level Company and the Stanley Works.



1936

Stanley manufactured its first utility knife.



1937

Henry Phillips, inventor of Phillips head screw, chose Stanley as the first company to begin making Phillips screwdrivers.

1844

Begin to manufacture ivory and boxwood rules.

1857

Stanley Rule & Level Company established by Henry Stanley. Stanley begins to manufacture levels and squares.

1876

Miter boxes were introduced.

1869

Purchased Bailey, Chaney and Company and acquired the right to manufacture tools under Bailey's patents.



1924

Stanley filed a patent for the ratcheting screwdriver.

1928

The Stanley Works broke into the electric hand tools market with an electric drill, screwdriver and bench grinder.

1930

Stanley made the first steel tape rule.



1954

Time Magazine published a cover story titled "Do-It-Yourself – The New Million Dollar Hobby". Stanley was ideally positioned to benefit from this trend and quickly developed products for this new market.

1980

The Stanley Works was presented the American Eagle Award from the American Supply & Machinery Manufacturers' Associ., Inc. for its "unusual across-the-board quality".



1969

The PowerLock Tape Rule represented Stanley as a part of Apollo 11's Lunar Landing Gear.

1999

Stanley launched the FatMax Tape Rule and the FatMax AntiVibe Hammer.

2013

Stanley launches the next generation of hand tools and power tools.

1963

Stanley opens the largest hand tool plant in the world in New Britain, CT. The same year, they introduce the PowerLock Tape Rule.



1998

Stanley acquires a maker of plastic storage products, including tool boxes



2011

Stanley launched Carbide blades.

2008

Stanley re-introduces Sweetheart planes.



1970

Stanley began producing manual staplers.

ACHIEVING UNPARALLELED PERFORMANCE WITH STANLEY® TOOLS

A BRAND YOU CAN TRUST

For over a century, we have built a legacy by producing some of the most well known hand tools and storage products in the world, all to help you build a legacy of your own. It is this rich history of innovation that has made **STANLEY®** a trusted name and industry pioneer.

In 1843, **STANLEY®** started to manufacture bolts, hinges, and other hardware by using wrought iron. By merging superior quality materials, constant innovation, and rigorous operational improvements, **STANLEY®** defined excellence and till today, is trusted by professionals on job sites around the globe.



FULL RANGE OF PRODUCTS FOR ALL PROFESSIONALS

Be it construction or mechanic tools, we have got you covered. **STANLEY®** provides a broad range of over 2,000 products in all tool categories. No matter what car you drive, what stores you shop at, or what building you work in, you can bet that we deliver the tools and solutions that you can count on, and you can be sure that we will keep making it better.

QUALITY THAT EXCEEDS STANDARDS

Most of the products produced by **STANLEY®** exceed government and industry standards such as ASME/ANSI, ISO and DIN. We push ourselves every day to deliver tough, strong, and reliable hand tools. We have state-of-the-art test facilities that cover solvent resistance and drop testing to ensure that our products meet critical standards. In each product category, we also perform specific performance and life tests to ensure product durability and quality.



Hardness Test



Corrosion & Solvent Test



Drop Test



Proof Torque

STANLEY® PROVIDES NOT ONLY TOOLS THAT HELP YOU GET THE JOB DONE, BUT ALSO HELP YOU TO GET IT DONE RIGHT.

INNOVATIVE DESIGN WITH GREAT FUNCTIONALITY

STANLEY® designs tools based on end user research and user insights. Our innovative processes are fashioned to determine what users want even before they know it. The brand new range of STANLEY® tools meet the demanding nature of all professionals within construction, renovation and automotive sectors. We are the pioneers in many hand tool categories and have created several patented features focused on solving problems faced by users. We have dedicated product design practices that tap into professional needs to conceptualize products that offer the best user benefits. From the field straight to the design team, we strive to offer valuable benefits to all professionals.

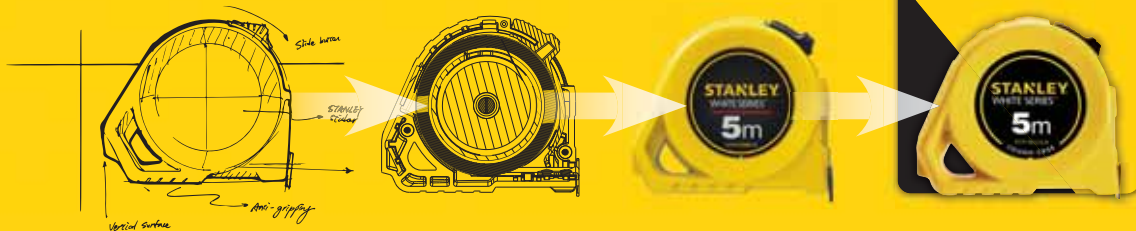

MANUFACTURING

STANLEY® has been managing and manufacturing tools for over a century. The company has built a brand synonymous with quality and assurance. Facilities located all over the world meticulously churn out quality tools to meet the ceaseless demands of our clients. Our best-in-class manufacturing process ensures that the final product is something to be proud of.

STANLEY® GLOBAL PRESENCE

- 20+ Global manufacturing sites and labs with similar process and quality controls for consistent quality.



USA

EUROPE

CHINA

TAIWAN



SHORT AND LONG TAPES

8

Short Tapes

Long Tapes

SQUARES, LEVELS & CHALK LINES

14

Squares

Levels

Marking

LASER & TORCHES

24

Laser Measurement

Cross Line Laser

Spot Lasers

Optical levels

Torches

KNIVES AND BLADES

32

Retractable Blade Knives

Knife Blade

Snap Off Knives

Safety Knives

Craft, Sport & Pocket Knives

Scrapers

SCREWDRIVERS

40

Cushion Grip

Thrifty

Multibit Screwdrivers

Ratcheting screwdrivers

FatMax®

PVC Handle

Precision screwdrivers Sets

CONTENTS

SAWS

56

Wood saws

Specialist Saws

Hack saws

Hack Saws Blades

PLANES, SURFORMS & CHISELS

62

Metal Planes

Shoulder planes

Specific planes

Block Planes

Plane Irons

Surform

Chisels

DEMOLITION & HAMMERS

70

Ripping Bars

Ball Pein hammers

Specific hammers

Nail- pulling hammers

CLAMPS & PLIERS

76

Vices

Pincers & Snips

Shears

Scissors

Pliers

AUTOMOTIVE TOOLS

94

Spanners

Wrenches

Angled Socket Wrenches

Wrenches Sets

Sockets & Socket Sets

Mixed Socket Sets

Ratchet

Hex Keys

Pipe Wrench

Air Tools

STAPLING, RIVETING & GLUING

112

Staple Guns

Staples

Riveters

Glue Guns

TOOL STORAGE & DECORATION

118

Storage

Toolboxes

Mobile Workshops

Tool Bag

Metal Tool Box

MIXED SETS

130

Mixed Sets

INDEX

133

Alpha Numeric

Product Description Alphabetical

STANLEY®

SHORT & LONG TAPES



Short Tapes

Long Tapes



NEW

STANLEY®

The rounded case and compact size that fits beautifully in the hand. It has round grooves on the surface, offering more ergonomic handling.

MORE ERGONOMIC DUE TO ROUNDED SHAPE/EDGE AND COMPACT CASE



- **Good Blade Standout®**
Allows user to work efficiently in different conditions
- **Yellow Case**
Easy to find on jobsite
- **ABS Case**
For good durability



High curvature blade for great standout



Nylon coating for extra durability

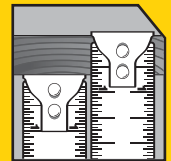

TRU-ZERO® END HOOK

Corrosion-resistant Tru-Zero® end hook for accurate measurements

STANLEY® FATMAX™



AUTO-LOCK TAPE RULES

Throughout its long history of manufacturing, STANLEY® has been driven by an unwavering commitment to quality, innovation and precision. These principles led to the design and manufacture of the Auto-Mock tape rule. With a blade that automatically locks at the length to which it is extended to the customizable hook system, STANLEY® continues to deliver innovations that matter

Auto-lock mode for blade control and long life

11 ft blade standout*

Detachable hook allows user to work efficiently in different conditions

BladeArmor™ coating for 10X** blade life



MADE IN USA WITH GLOBAL MATERIALS™

FATMAX® SHORT TAPES



- Patented reverse lock mechanism
- BladeArmor® coating on the first 80mm and complete Mylar® coated blade
- Detachable hook
- Bi-material case for comfort

SKU	DESCRIPTION
XTHT0-33503	5M/E X32 in Cutcase - Metric / Imperial
XTHT0-33504	8M/E X32 in Cutcase - Metric / Imperial

MADE IN USA WITH GLOBAL MATERIALS™

POWERLOCK TAPES



- High impact chrome ABS case for tough onsite jobs
- Mylar® polyester film extends life of entire blade
- Corrosion-resistant Tru-zero® end hook for accurate measurements
- Belt clip for ease of storage



SKU	OLD SKU	DESCRIPTION
0-33-231T	-	3M/E x 13mm Metric- Imperial
STHT33158-8	0-33-158T	5M/E x 19mm Metric- Imperial
STHT33428-8	0-33-428T	8M/E x 25mm Metric- Imperial
STHT33463-8	0-33-463T	10M/E x 25mm Metric- Imperial



For half a decade, **STANLEY®** has stayed true to the iconic image of the **PowerLock®** Tape Rule, improving only on its performance and durability. Furthermore, **STANLEY®** has maintained the heritage of manufacturing tapes in New Britain, CT, USA*. This tape design is a dedication to the original **PowerLock®**, brandishing the same design and markings of the first

PowerLock® Tapes manufactured in 1963. Since its launch 50 years ago, it remains one of the best selling tapes in the world. Each **PowerLock®** Tape features a sliding lock, holding the blade in place, a rigid 7 feet standout **Mylar®** protective blade coating for durability and a **Tru-Zero®** end hook for accurate measurements.

*Manufactured with global materials

TYLON™ TAPES



- Tylon™ coated blade provides anti-glare readings
- Soft touch case
- Tru-Zero® hook for accurate internal and external measurements

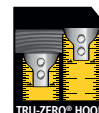

SKU	OLD SKU	DESCRIPTION
STHT30687-8	0-30-687	3M x 13mm Metric
STHT30697-8	0-30-697	5M x 19mm Metric
STHT30657-8	0-30-657	8M x 25mm Metric
STHT30686-8	0-30-686	3M/E x 13mm - Metric / Imperial
STHT30696-8	0-30-696	5M/E x 19mm - Metric / Imperial
STHT30656-8	0-30-656	8M/E x 25mm - Metric / Imperial

STANLEY® SHORT TAPE RULE



- Yellow blade for improved visibility
- High-impact ABS case offers durability



SKU	DESCRIPTION
STHT30258-8	5m x 19mm - Metric
STHT30259-8	8m x 25mm - Metric
STHT30261-8	3m/10' x 13mm - Metric / Imperial
STHT30265-8	5m/16' x 19mm - Metric / Imperial
STHT30266-8	8m/26' x 25mm - Metric / Imperial

CLOSED CASE STEEL BLADE



- 9.5mm wide yellow blade - abrasion resistant
- 2 colour graduations - easy to read in all conditions
- High impact, high visibility yellow ABS case

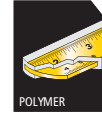

SKU	OLD SKU	DESCRIPTION
0-34-102	-	10M x 10mm Metric
0-34-105	-	20M x 10mm Metric
STHT34104-8	0-34-104	15M/E x 10mm - Metric / Imperial
STHT34107-8	0-34-107	30M/E x 10mm - Metric / Imperial

CLOSED CASE FIBERGLASS BLADE



- High-impact case for durability
- Reinforced fiberglass blade for accurate measurements
- High visibility case make it easy to detect on the job

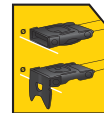

SKU	OLD SKU	DESCRIPTION
STHT34297-8	0-34-297	30M x 10 mm Metric
STHT34298-8	34-298	50M x 10 mm Metric
STHT34260-8	0-34-260	15M/E x 10mm - Metric / Imperial
STHT34262-8	0-34-262	30M/E x 10mm - Metric / Imperial
STHT34263-8	34-263	50M/E x 10mm - Metric / Imperial

OPEN CASE FIBERGLASS BLADE



- Double sided blade graphics for an easy read
- Corrosion-resistant Tru-zero folding end hook for accurate measurements
- Grip handle for comfortable portage



SKU	DESCRIPTION
2-34-795	60M x 10mm Metric
2-34-777	100M x 10mm Metric
STHT34791-8	30M/E x 10mm - Metric / Imperial
STHT34794-8	60M/E x 10mm - Metric / Imperial

STANLEY®

SQUARES, LEVELS & CHALK LINES



Squares

Levels

Marking Tools



STANLEY®

CLASSIC BOX-BEAM LEVEL

The **STANLEY®** CLASSIC BOX-BEAM features a wide range of levels that come in various sizes. New features offer better visibility, readability, durability and accuracy.

SOFT MATERIAL
used to make shock-absorbing end caps

EXCELLENT ACCURACY

center vial with 0.05mm/1m

2 PLUMB VIALS

for easy readability

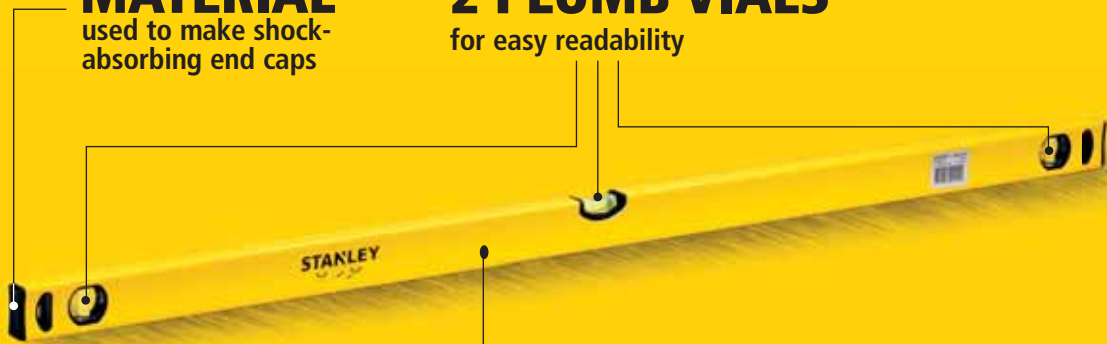

strong yet lightweight

ALUMINUM FRAME
suitable for all-purpose durability



MILLING SURFACE

to provide better accurate measurement

USER TIPS

- The hang-hole allows for easy storage
- Measuring can be done from either direction, offering excellent accuracy



JOBMASTER SQUARE



- Protective lacquered coating
- Embossed graduations for easy reading

SKU	DESCRIPTION	
45-912	12" x 8" Metric-Imperial	
	Length Body	Length Tongue
	8" X 1"	12" x 1-1/2"

TRY SQUARE CAST ZINC HANDLE



- Metric / Imperial marking on ruler
- Cast zinc handle



SKU	BLADE	HANDLE
E-46530	150mm - 6"	124mm - 4-7/8"
E-46532	200mm - 8"	124mm - 4-7/8"
E-46534	250mm - 10"	184mm - 7-1/4"
E-46536	300mm - 12"	184mm - 7-1/4"

DIE CAST COMBINATION SQUARE

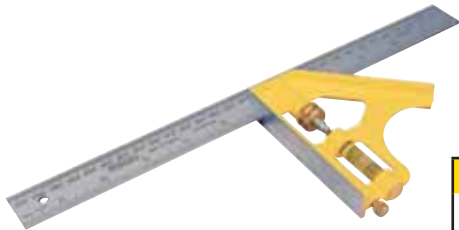

- Precision die-cast body with 3 precision machined faces for accuracy
- Metric/imperial graduations



SKU	DESCRIPTION
2-46-028	300mm Metric- Imperial

CARPENTER STEEL SQUARE ALUMINIUM HANDLE



- Extruded aluminium stock is triple riveted to the blade for strength and accuracy
- Stock bevelled for setting out both 90° and 45° angles

SKU	DESCRIPTION
1-45-686	200mm(L) / 300mm(W)

CARPENTER STEEL SQUARE



- Buffed finish and protective lacquer coating
- Face graduated every 2mm, reverse of blade every 1/8" for detailed work

SKU	DESCRIPTION	
45-600	400mm Metric-Imperial	
	Length Body	Length Tongue
	24" x 12"	12" x 1-1/2"

STANLEY CLASSIC BOX LEVELS



- Block magnified center vial makes it easier to read
- Vial accuracy : 0.5mm/m
- Large tubular side vials
- Soft end caps makes it more durable in case of shocks
- Milling surface will not bend out of shape on impact
- Hang hole allows for easy storage



SKU	OLD SKU	DESCRIPTION
STHT43118-8	STHT1-43118	30CM
STHT43102-8	-	40CM
STHT43103-8	-	60CM
STHT43104-8	-	80CM
STHT43105-8	STHT1-43105	100CM
STHT43106-8	STHT1-43106	120CM
STHT43107-8	STHT1-43107	150CM
STHT43108-8	STHT1-43108	180CM
STHT43109-8	STHT1-43109	200CM

STANLEY CLASSIC BOX LEVELS - MAGNETIC

- Block magnified center vial makes it easier to read
- Vial accuracy : 0.5mm/m
- Large tubular side vials
- Soft end caps makes it more durable in case of shocks
- Milling surface will not bend out of shape on impact
- Hang hole allows for easy storage



SKU	DESCRIPTION
STHT1-43110	40CM - Magnetic
STHT1-43111	60CM - Magnetic

MLH ALUMINIUM ANTICHOC LEVELS - 1 PLATE



- Epoxy paint resistant to abrasion and bad weather
- Unbreakable, reversible and tinted antishock Altuglass vials



SKU	DESCRIPTION
1-42-311	30cm - 2 vials
1-42-312	40cm - 2 vials
1-42-313	50cm - 2 vials
1-42-314	60cm - 2 vials

TMLH ALUMINIUM ANTICHOC LEVELS - 2 PLATES



- 2 unbreakable, reversible and tinted antishock Altuglass vials
- Massive body in light resistant aluminium alloy, epoxy paint



SKU	DESCRIPTION
1-42-253	60cm - 2 vials
1-42-254	80cm - 2 vials

FATMAX® XTREME™ TORPEDO MAGNETIC - ALUMINIUM



- Die cast aluminium body
- 3 vials (vertical, horizontal, plumb and 45° for wide usage)



SKU	DESCRIPTION
0-43-609	25cm - 3 vials

FATMAX® TORPEDO MAGNETIC - ALUMINIUM



- Die-cast aluminum body provides maximum durability
- Magnified center vial

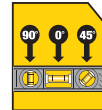

SKU	DESCRIPTION
0-43-603	25cm - 3 vials

TORPEDO GP - ALUMINIUM



- Made in aluminium, high resistance, epoxy paint
- 2 extremely reliable tubular vials

SKU	DESCRIPTION
1-42-799	25cm - 2 vials

TORPEDO LEVEL MAGNETIC - ALUMINIUM

- Strong & lightweight aluminium body ideal for small installations
- 3 vials: horizontal, plumb and 45° for wide usage

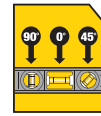

SKU	DESCRIPTION
STHT42465-8	23cm - 3 vials

TORPEDO LEVEL - ABS

- Lightweight injection moulded ABS body for strength
- 3 tubular vials horizontal, plumb and 45°

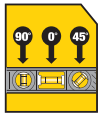
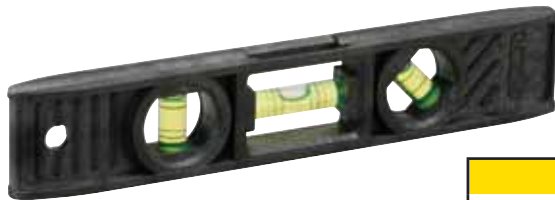

SKU	DESCRIPTION
0-42-294	20cm - 3 vials

TORPEDO LEVEL - HEAVY DUTY

- Heavy-duty aluminum frame for accuracy and durability
- Bi-material body with rubber ends for shock absorption
- Non-marring feet can be used on finished surfaces
- Magnetic base allows hands-free operation on metal surfaces

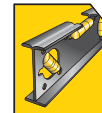
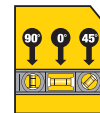

SKU	DESCRIPTION
STHT43511-8	9" Hi Impact

POCKET LEVEL - MAGNETIC

- Strong molded plastic casing for durability
- Accuracy 1mm/m



SKU	DESCRIPTION
0-42-130	Mini Pocket Level

POWERWINDER CHALK LINE SET



- 3.5 to 1 gear ratio for 3.5 time faster rewind
- Case holds 45g chalk to reduce filling times

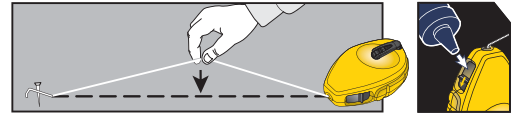

SKU	DESCRIPTION
0-47-465	Set - 30M Chalk Line, 115g Blue Chalk & Level

METAL CHALK LINE AND PLUMB BOB



- Die cast aluminium case for durability
- Stainless steel end hook for added durability and rust prevention

SKU	DESCRIPTION
0-47-100	30m Stanley Metal Chalk Line

STANLEY CHALK LINE SET



- High impact ABS case for durability
- Sliding door for quick and easy refill

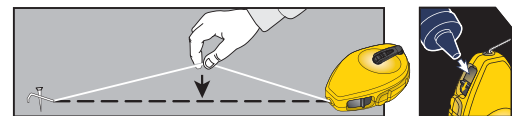

SKU	OLD SKU	DESCRIPTION
STHT47443-8	0-47-443	30m Chalk Line Set - 30M Chalk Line 115g Blue Chalk & Level

STANLEY CHALK LINE



- High impact ABS case for durability
- Holds 100ft of String

SKU	OLD SKU	DESCRIPTION
STHT47440-8	0-47-440	30m - Single

CHALK POWDER REFILL



- Blue: all round colour for interior and exterior use
- Red: for external masonry work, indelible

0	1	2	3	4
TEMPORARY			PERMANENT	

0	1	2	3	4
TEMPORARY			PERMANENT	

SKU	OLD SKU	DESCRIPTION
STHT47403-8	1-47-403	115 Grs Blue
STHT47404-8	1-47-404	115 Grs Red

ARCHITECT'S PLUMB BOB



- Polished lacquered solid brass construction, resists rust

SKU	DESCRIPTION
0-47-973	225 Grs

PERMANENT MARKER - BLACK



- Quick drying water resistant ink marks on almost any surface

SKU	DESCRIPTION
0-47-316	2 pc Fine Tip Black

ODOMETER MW40M



Durable traditional counter measuring wheel for best value

- Folding kick stand
- Die cast aluminium wheel with wear resistant rubber tread for improved traction & longer life
- Folding wheel mount
- Heavy Duty metal folding handle & rubber hand grip for maximum durability
- 5 digit counter with manual reset button for superb accuracy

SKU	DESCRIPTION
1-77-174	MW40M - 5 Digit Counter Measuring Wheel

ODOMETER DMW40



Designed for exterior use, this sturdy measuring wheel folds down for easy storage and has a digital counter with data storage memory

- Heavy Duty metal folding handle & rubber hand grip
- Auto power off after 2 minutes of suspended use
- Recall last reading (optional) when auto power off
- Die cast Aluminium wheel with wear resist

SKU	DESCRIPTION
1-77-176	DMW40 Digital Measuring Wheel, 254mm Wheel



STANLEY®

LASER & TORCHES



Laser Measurement

Cross Line Laser

Spot Lasers

Optical levels

Torches



STANLEY

LASER MEASUREMENT

POINT. CLICK. MEASURE. DONE.

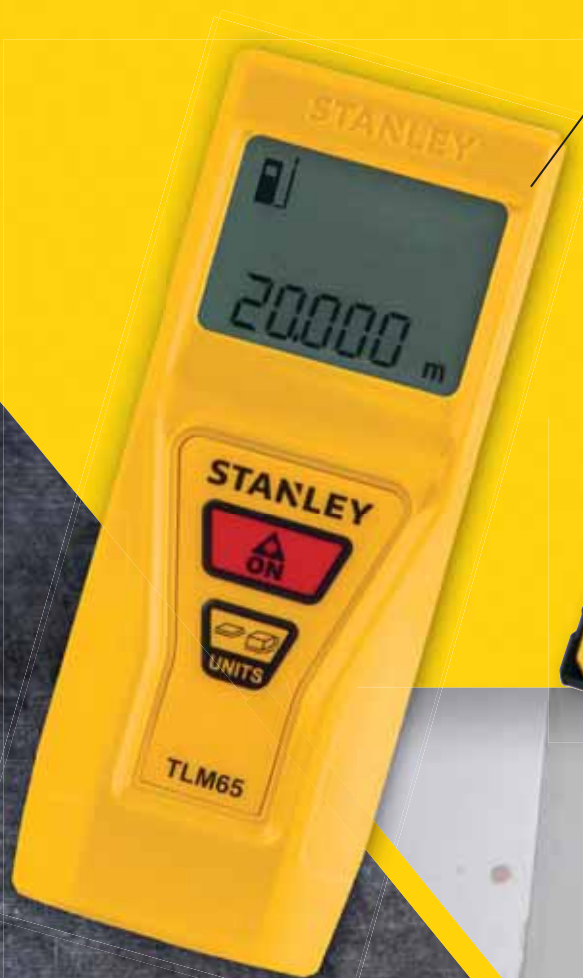

STHT1-77138



STHT1-77139



STHT1-77140



TLM 65 - 20M

STHT1-77032

- **Easy to Use**
On off button also shows battery indicator
- **Distance / Area / Volume**
A quick estimation tool
- **Continuous Measurement**
Gives accurate active measurement - replacing the traditional tape measure
- **Small compact size**



TRUE LASER MEASUREMENT - 100M



- Accuracy: +/- 1mm
- Distance/area/volume calculation
- Continuous measurement "tracking" function
- Toe end piece for accurate positioning
- 20 memory storage function
- Tripod mounting thread

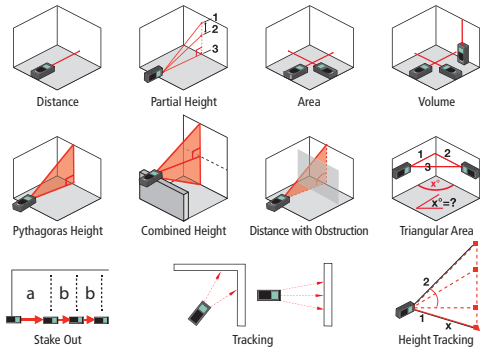

SKU	DESCRIPTION
STHT1-77140	TLM 330 - 100M Range

TRUE LASER MEASUREMENT - 50M



- Accuracy: +/- 1,5mm
- Distance/area/volume calculation
- 5 memory storage function
- Continuous measurement "tracking" function

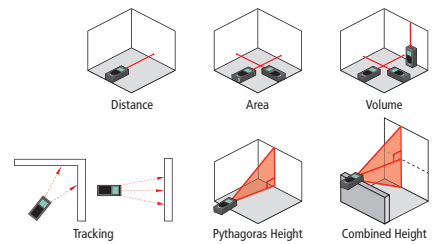

SKU	DESCRIPTION
STHT1-77139	TLM 165 - 50M Range

TRUE LASER MEASUREMENT - 30M



- Accuracy: +/- 2mm
- Distance/area/volume calculation
- Continuous measurement "tracking" function
- Finds distance from a target quickly and easily

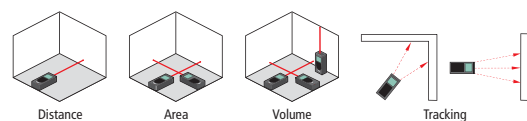

SKU	DESCRIPTION
STHT1-77138	TLM 99 - 30M Range

TRUE LASER MEASUREMENT - 20M



- 20m range ideal for DIY use
- One touch operation
- Point, click, measure: a quick and easy to use model with distance, area and volume functions
- Continuous measurement "tracking" function

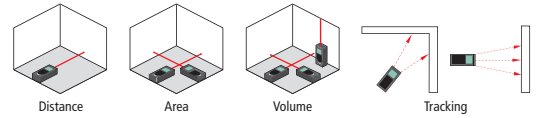

SKU	DESCRIPTION
STHT1-77032	TLM 65 - 20M Range

CROSS LINE LASER - FATMAX® SCL



- Working range 10m - up to 30m with a detector
- Interior/Exterior use with detector
- Projects 1 horizontal and 1 vertical line to create a cross line (V:130° /H:130°)
- Pulse beam mode allows operating outdoors in combination with the detector

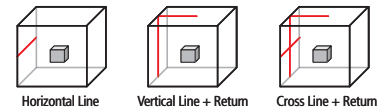

SKU	DESCRIPTION
1-77-320	SCL Laser with carry bag, L- type bracket, clip, tripod, batteries

CROSS LINE LASER - CL90i



- Projects lines up to 30m using a detector (supplied)
- Ideal for laying out stud walling, pipe work, shelving, lighting, kitchens, fencing, landscaping & tiling
- Self levelling

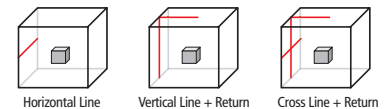

SKU	DESCRIPTION
1-77-021	CL90i Laser with hard carry case, 3xAAA batteries

SPOT LASER - SLP 5



- Working range 30m (spot) / 15m (line) - up to 50m with a detector
- Projects 5 beams (3 horizontal, 1 vertical, 1 plumb) and 1 horizontal line >120°
- Magnetic pivoting base

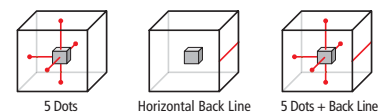

SKU	DESCRIPTION
1-77-319	SLP 5 Laser, laser grid target, carry case, batteries

THE COMPACT YET POWERFUL LASER SOLUTION

'Lighter and brighter', that's Stanley's line laser range in a nutshell. These compact yet powerful pointers offer extreme accuracy for all indoor and outdoor applications. Multiple precision vials make leveling and aligning a breeze while the pointer's solid, die-cast base ensures superior stability. Best of all, Stanley's renowned weather-proof casing lets you work anywhere with total peace of mind, no matter the conditions.



CROSS LINE LASER - MULTILINE SML



- Working range 15m / 50m with a detector
- Projects 1 horizontal and 4 vertical lines to create a crossline
- Working environment : Interior / Exterior use
- Magnetically dampened pendulum
- Pulsed beam mode allows operation outdoors in combination with the detector (supplied)

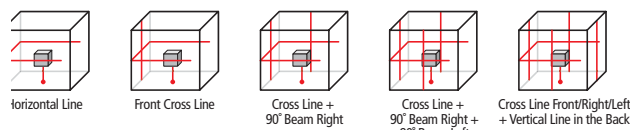

SKU	DESCRIPTION
1-77-322	Multi line laser SML, laser glasses, hard case, batteries

OPTICAL LEVEL - AL24



- High quality, competitively priced 24X automatic optical level, supplied with Tripod and Rod
- Large easy to use focusing knob
- Right angle prism for easy bubble viewing
- Accuracy 1.6mm @45mm
- IP rating of IP54
- Working Range - 90m



SKU	DESCRIPTION
1-77-160	Tripod 1,60m, Measuring Rod 5m, Plumb Bob, Hard carry case

PERFORMANCE TORCH RECHARGEABLE - FATMAX®



- Aluminium body , 70 lumens of light - High visibility
- Ni MH rechargeable battery, water resistant

IPX4
Protected against splashing water from all angles.



SKU	DESCRIPTION
1-95-154	Aluminium body - Rechargeable Ni-MH batteries

TRIPOD TORCH - LED TECHNOLOGY



- Adjustable head - 30 lumens of light
- 40 hours run time

IPX4



SKU	DESCRIPTION
0-95-112	MaxLife Standard - Runs on 3, 6, or 9 AA batteries (not included)

HEADLAMP - FATMAX®



- High Tech LED with 8 hours run time
- Durable casing, over head strap
- Drop/Shatterproof



SKU	DESCRIPTION
FMHT0-70767	FatMax® Headlamp



STANLEY®

KNIVES & BLADES



Retractable Blade Knives

Knife Blade

Snap Off Knives

Safety Knives

Craft, Sport & Pocket Knives

Scrapers



NEW

STANLEY®

PROFESSIONAL SNAP-OFF KNIFE



UNIQUE ERGONOMIC THUMB PAD
enables firm and comfortable holding positions

RIGID STAINLESS STEEL BARREL
provides smooth action and is corrosion resistant



HIGH PERFORMANCE BLADE
MADE BY STANLEY® with quality and great cutting life



NECK DOWN
ensures excellent grip control and the ultimate cutting performance



CROSS STOP DESIGN



STHT10264-8
ABS+TPR



STANLEY® knives are equipped with Stanley's high quality blades made by Stanley's UK plant where more than 32,000 KM of blades are made annually. These blades are made with intensive testing for quality.



FATMAX® RETRACTABLE BLADE KNIVES WITH 5 BLADES



- Blade wiper removes excess dirt and protects knife
- Blade clamp eliminates blade wobble, gives control
- Soft touch panels/grips allow better control, fewer slips
- Pop-up blade dispenser for easy access and fast changeover
- Push button blade change, no tools needed



SKU	DESCRIPTION
0-10-778	Utility Knife - 170 mm

99E ORIGINAL STANLEY RETRACTABLE BLADE KNIVES



- The one and only original Stanley® retractable knife
- InterLock® nose firmly secures blade into knife

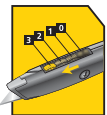

SKU	DESCRIPTION
10-099	Retractable Utility - 152mm

1992 TRIMMING KNIFE BLADE



- The original heavy duty, general purpose blade
- Blades fit all standard Stanley® knives
- Ideal for carpet, vinyl and any other material requiring a stiffer and stronger blade



SKU	DESCRIPTION / PACKAGING
0-11-921	5 pieces Carded
1-11-921	Box of 100 pieces
6-11-921	10 Dispensers of 10 pieces

1996 TRIMMING KNIFE BLADE



- With deeper hook for cutting thicker materials
- Fits most standard utility knives

SKU	DESCRIPTION / PACKAGING
1-11-983	Box of 20 x 5 pieces

CRUISER - SNAP OFF KNIVES



STHT10265-8



STHT10266-8

- Ergonomic design of thumb pad and neck down create comfortable grip and control
- Bi-material TPR handle with soft grip or full ABS version for durability
- Fits application needs from light to heavy duty and specially designed to improve cutting performance
- Removable blade snapper in the knife cap
- Storage of 2 spare blades

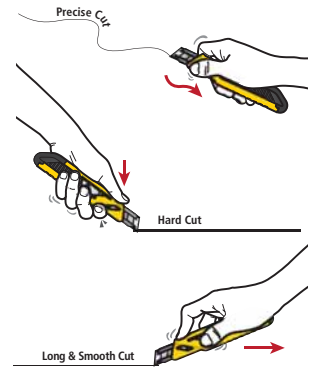

SKU	DESCRIPTION
STHT10265-8	Cruiser ABS : 18mm ABS Auto Lock Snap-Off Knife
STHT10266-8	Cruiser TPR : 18mm TPR Auto Lock Snap-Off Knife

DYNAGRIP® 18 MM - SNAP OFF KNIFE



- Ergonomic handle in flexible elastomer
- Blade locking system for greater safety

SKU	OLD SKU	DESCRIPTION
STHT10418-8	0-10-418	18 mm

DYNAGRIP® 25 MM - SNAP OFF KNIFE



- 25 mm blade and 0.7 mm thickness improving performance during intensive work
- Blade divisible into 7 segments for less frequent blade changes

SKU	DESCRIPTION
STHT10425-8	25 mm

SELF LOCKING 18 MM - SNAP OFF KNIFE



- 2 blade holder in the handle
- Moulded body for strength and durability



SKU	DESCRIPTION
0-10-280	18mm

SELF LOCKING 9 & 18 MM - SNAP OFF KNIVES



- Two part moulded body that allows rapid blade changing
- Multi-position push button for quick, easy use

SKU	DESCRIPTION
STHT10151-8	SM Self Locking - Blade 18 mm
STHT10150-8	SM Self Locking - Blade 9 mm

SPRINGBACK KNIFE



- Spring loaded blade automatically retracts when the slider is released



SKU	OLD SKU	DESCRIPTION
STHT10189-8	0-10-189	Red Colour - Retracting blade - 155mm

WOODEN FOLDING UTILITY KNIFE



- Classic wood handle combines performance and feel (FSC certified)
- Quick blade blade mechanism (roll forward)

SKU	DESCRIPTION
0-10-073	Craft, Sport & Pocket Folding Utility Knife

SNAP OFF BLADES - 25 MM



- Reinforced thickness specially for intensive use (1mm thick)



Fits Stanley 25mm snap-off blade knives and most other 25mm Snap-Off blade knives



SKU	DESCRIPTION	PACKAGING
STHT11325-8	25mm	Dispenser of 10 pieces

SNAP OFF BLADES - 9 & 18 MM



- Spare blade dispenser with blade breaker and storage of used segments



Fits Stanley 18mm snap-off blade knives and most other 18mm Snap-Off blade knives



Fits most 9mm snap-off blade knives



SKU	DESCRIPTION	PACKAGING
1-11-301	18mm	10 Dispensers of 10 pieces
2-11-301	18mm	Dispenser of 5 pieces
1-11-300	9mm	10 Dispensers of 10 pieces

GLASS SCRAPER

- Retractable rectangular blade
- Brass push button



SKU	DESCRIPTION
0-28-500	Retractable rectangular blade - 95mm

WINDOW SCRAPER

- Supplied with 1 heavy duty blade



SKU	DESCRIPTION
0-28-590	ABS / 170mm - 60mm



**THE RANGE IS EQUIPPED WITH
BLADES MADE WITH HIGH QUALITY
CARBON STEEL FOR LONG LASTING
DURABILITY. ”**

**“ ITS HIGH IMPACT
POLYMER COMPONENTS
ALSO PLAY A ROLE IN THE
TOOL'S LONGEVITY. ”**

**PROFESSIONAL
SNAP-OFF KNIFE**

STANLEY®

SCREWDRIVERS



Cushion Grip

Thrifty

Multibit Screwdrivers

Ratcheting screwdrivers

FatMax®

PVC Handle

Precision screwdrivers Sets



STANLEY®

CUSHION GRIP™ SCREWDRIVERS RANGE

The **STANLEY® CUSHION GRIP™** range is fully patented and meets ANSI standards, proving the range's durability and precision. These tools have easy-to-hold handles that are comfortable and ergonomic.



Phillips®



Flat / Slotted

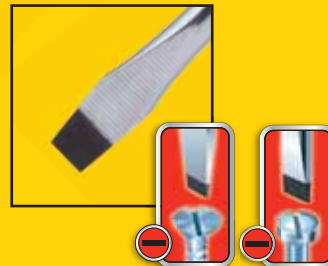

TORX



FUN FACT

STANLEY® was the first company to make Phillips® screwdrivers in 1937. It was chosen by Henry Phillips, the inventor of the Phillips® head screw.

UNIT PACK

Bold and attractive single packs exploit key features and provide clear user information. Minimal packaging allows full tactile opportunities with security.

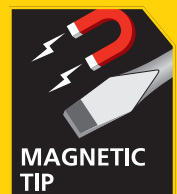
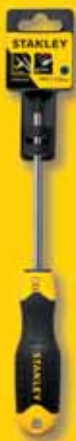

CUSHION GRIP 3 SCREWDRIVERS : STANDARD - TORX - PHILLIPS

- Bi-material (PP+TPR) soft grip handle providing excellent comfort
- Chrome Vanadium (Cr-V) blade for durability
- Magnetic tips for easy pick up and screw locator
- Three-sided handle allowing more torque with anti-slip and anti-rolling features reducing handle slippage
- Ergonomic design with finger point in neck-down area for precise control
- Built-in hang hole for easy storage
- Screw tip identification on the handle for organization

> STANDARD SCREWDRIVERS

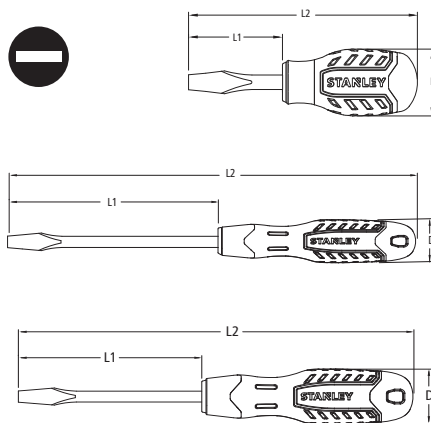

SKU	OLD SKU	DESCRIPTION
STHT65180-8		3mm X 75mm
STHT65181-8		3mm X 100mm
STHT65182-8		3mm X 125mm
STHT65183-8		3mm X 150mm
STHT65186-8		5mm X 75mm
STHT65187-8		5mm X 100mm
STHT65188-8		5mm X 150mm
STHT65189-8		5mm X 200mm
STHT65193-8		6.5mm X 150mm
STHT65194-8	2-65-194	6.5mm X 200mm
STHT65195-8	2-65-195	6.5mm X 250mm
STHT65196-8		8mm X 150mm
STHT65197-8		8mm X 200mm
STHT65198-8		8mm X 250mm

CUSHION GRIP 3 SCREWDRIVERS : STANDARD - TORX - PHILLIPS

> TORX SCREWDRIVERS

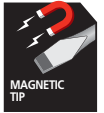
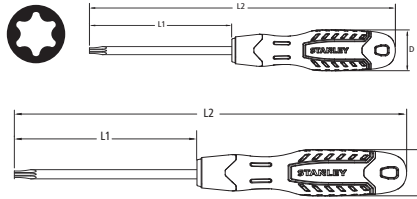

SKU	DESCRIPTION
STHT65148-8	T10 X 80MM
STHT65149-8	T15 X 80MM
STHT65150-8	T20 X 120M
STHT65151-8	T25 X 120MM
STHT65153-8	T30 X 120MM
STHT65154-8	T40 X 120MM

> PHILLIPS SCREWDRIVERS

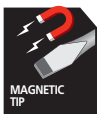
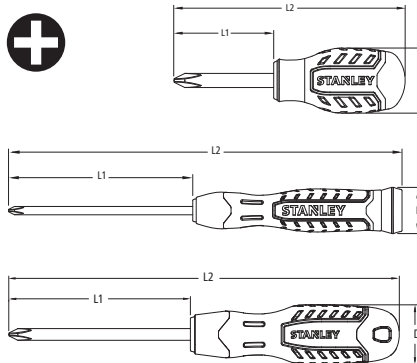

SKU	OLD SKU	DESCRIPTION
STHT65162-8		# 1 X 75mm
STHT65163-8		# 1 X 100mm
STHT65164-8		# 1 X 150mm
STHT65165-8		# 1 X 200mm
STHT65167-8	0-64-940	# 2 X 100mm
STHT65169-8	0-64-941	# 2 X 150mm
STHT65170-8	2-65-170	# 2 X 200mm
STHT65171-8	2-65-171	# 2 X 250mm
STHT65172-8		# 3 X150mm
STHT65173-8		# 3 X200mm
STHT65174-8		# 3 X250mm

CUSHION GRIP 6 PIECES SET - MAGNETIC TIP



SKU	DESCRIPTION
0-65-007	Flat : 6.5mm X 200mm, Flared : 3mm X 75mm, 5mm X 100mm, 6.5mm X 150mm, Phillips : PH #1 X 75mm, PH #2 X 150mm

CUSHION GRIP 6 PIECES SET - MAGNETIC TIP



SKU	DESCRIPTION
0-65-009	Flared : 5mm X 100mm, 6.5mm X 45mm, 6.5mm X 150mm, Phillips : PH #1 X 75mm, PH #2 X 45mm, PH #2 X 100mm + Voltage Tester

CUSHION GRIP 8 PIECES SET - MAGNETIC TIP



SKU	DESCRIPTION
0-65-011	Flared : 3mm X 75mm, 5mm X 100mm, 6.5mm X 45mm, 6.5mm X 150mm, Phillips : PH #0 X 60mm, PH #1 X 75mm, PH #2 X 45mm, PH #2 X 150mm

CUSHION GRIP 6 PIECES SET - MAGNETIC TIP

NEW
 2024
 100%
 100%
 100%



x6

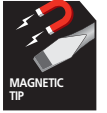

SKU	DESCRIPTION
STHT92002-8	Flared : 6 pcs Set - Flat 5.0mm X 100mm, 6.5mm X 100mm, 6.5mm X 45mm, Phillips : PH #1 X 100mm, PH #2 X 100mm, PH #2 X 45mm + Voltage tester

CUSHION GRIP 8 PIECES SET - MAGNETIC TIP

NEW
 2024
 100%
 100%
 100%



x8

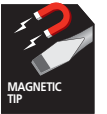

SKU	DESCRIPTION
STHT92004-8	Phillips : PH #0 X 60mm, PH #1 X 100mm, PH #2 X 150mm, PH #2 X 45mm, Flat : 3mm X 75mm, 5mm X 100mm, 6.5mm X 150mm, 6.5mm X 45mm

CUSHION GRIP 10 PIECES SET - MAGNETIC TIP



x10

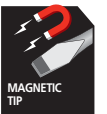

SKU	DESCRIPTION
2-65-005	Flared : 3mm X 75mm, 5 mm X 100mm, 6.5mm X 45mm, 6.5mm X 150mm, 8mm X 150mm, Phillips : PH0 X 60mm, PH #1 X 75mm, PH #2 X 45mm, PH #2 X 100mm, PH #3 X 150mm

THRIFTY - PHILLIPS SCREWDRIVERS



- Nickel plated boron steel bar
- Heat treated tip

SKU	DESCRIPTION
0-60-001	PH #1 x 100
0-60-002	PH #2 x 100

4 PIECES SET THRIFTY - BASIC SCREWDRIVERS



x4

SKU	DESCRIPTION
STHT0-60017	Flat : 5 x 75 mm, 6.5 x 150 mm. Phillips : PH #1, PH #2. + pocket driver

THRIFTY 6 PIECES SET - BASIC SCREWDRIVERS



- Comes with plastic rack for easy storage

x6

SKU	DESCRIPTION
60-060	Flat : 3, 4, & (2) 6", Phillips : PH #1 & PH #2

10 & 20 PIECES SETS THRIFTY - BASIC SCREWDRIVERS



SKU	DESCRIPTION
0-60-100	10 pcs Set Flared : 35mm, 45mm, 75mm, 100mm, 150mm, Flat : 150mm Stubby, Phillips : PH #1, PH #2, PH #2 Stubby
0-60-220	Flared : 6.5 x 40mm (2 pcs), 5 x 75mm (2 pcs), 6.5 x 100mm, 5 x 150mm, 6.5 x 150mm Phillips : PH2 x 40mm, PH1 x 100mm (2 pcs), PH2 x 100mm (2 pcs), 6 Piece Instrument Set 2 x Hex Keys

6 PIECES SET SCREWDRIVERS - PRO



- Resistant to high torques and impact
- Comfortable handles
- Cr-V steel heat treated and nickel plated **magnetic tip**
- Comes in plastic case, PVC bag



SKU	DESCRIPTION
69-170	Flat : 3/16" x 4", 3/16" x 6", 1/4" x 4", 1/4" x 6"; Phillips : PH #1 x 4", PH #2 x 4",

10 PIECES SET SCREWDRIVERS - PRO



- Resistant to high torques and impact
- Comfortable handles
- Cr-V steel heat treated and nickel plated **magnetic tip**
- Comes in plastic case, PVC bag



SKU	DESCRIPTION
69-172	10 pcs/set (D/B + PVC Bag) Flat : 3/16 x 3", 3/16 x 4", 3/16 x 6", 1/4 x 1-1/2", 1/4 x 4", 1/4 x 6"; Phillips : #1 x 4", #2 x 1-1/2", #2 x 4", #3 x 6"

25 PIECES SET PISTOL GRIP - RATCHETING SCREWDRIVERS

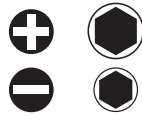

- Pistol Grip Screwdriver locks into 45°, 90° and 180°
- Removable cap with bit storage
- 3 positions switch

x25

SKU	DESCRIPTION
0-63-022	25 pcs Pistol Grip Ratchet SD 6 Large bits: Flat: 5, 6, 7 mm - Phillips: Ph 1, 2, 3 24 standard bits: Phillips # 0, # 1, # 2 (X3), # 3 - Flat: 5, 6, 7mm Hex tips 2, 3, 4, 5, 5.5, 6 mm - S1, S2, S3 Torx: T10, T15, T20, T25, T27, T30; 6 Sockets: 5, 6, 8, 9, 10, 11 mm

RATCHETING MULTIBIT SCREWDRIVER + 10 BITS

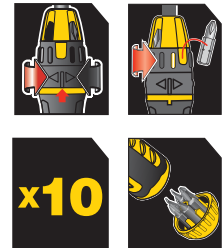
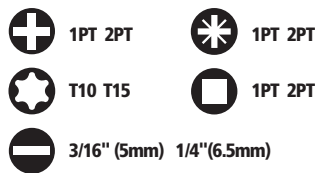

x10

SKU	OLD SKU	DESCRIPTION
STHT68010-8	0-68-010	Multibit Ratcheting screwdriver + 10 bits

STUBBY MULTIBIT SCREWDRIVER - MAGNETIC

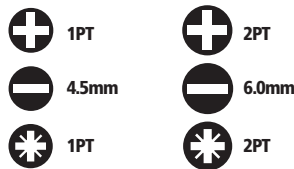

- Magnetic bit holder for speedy and secure changeover of bits
- Durable bi-material handles with comfrot grip
- Includes (6) CR-V bits with internal bit storage for easy access to bits-end cap carries 6 bits



x6



SKU	DESCRIPTION
0-66-357	Stubby with magnetic tip

MULTIFUNCTIONAL SCREWDRIVER SET



- Interchangeable bars maximize versatility
- Reduces the number of tools user needs to carry
- Storage case included
- Includes: 1/8" Standard Bar, 3/16" Standard Bar, 1/4" Standard Bar, Opt Phillips® Bar, 1pt Phillips® Bar, 2pt Phillips® Bar, 1 Tack Puller, 1 Brad Awl, 1 Hook Driver



SKU	OLD SKU	DESCRIPTION
STHT62511-8	0-62-511	9-Way Screwdriver

10-WAY FLEXIBLE SCREWDRIVER SET

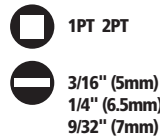

- 10 Replaceable 1/4" bits and adapter
- Comfortable bi-material handle
- Bit magazine with belt clip



SKU	OLD SKU	DESCRIPTION
STHT62508-8	0-62-508	10 Ways Flexi PH #1, PH #2, PH #3 Torx T15, T20 Square 1, 2 Flared 4mm, 5mm, 6mm

BITS SETS



- ISO 1173, ISO 2380-1, ISO 2351-1
- S2 Steel, 20% higher torque vs Cr-V
- HRC 60

SKU	DESCRIPTION
STHT72680-8L	Bits PH2 – 25mm
STHT72678-8L	Bits PH2 – 50mm

6 PIECES BI-MAT PRECISION SCREWDRIVER SET



- +** OPT 1PT
- 1.4mm 2.0mm
2.4mm 3.0mm

- Swivel-head handles provide tightening precisely
- Tough, plastic handles with soft cushion grip for comfort
- Plastic storage case included

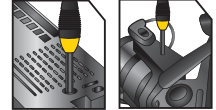

x6

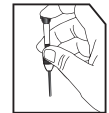

Plastic Handle

SKU	OLD SKU	DESCRIPTION
STHT66052-8	0-66-052	Bimaterial - 6 pcs set

6 PIECES PRECISION INSTRUMENT SCREWDRIVER SET



- +** OPT 1PT
- 1.4mm 2.0mm
2.4mm 3.0mm

- Swivel-head handles provide tightening precisely
- Bright, plated shafts are fluted for a steady, solid grip
- Hardened and tempered steel blades with blued finish to resist corrosion
- Plastic storage case included

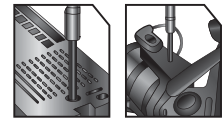

x6

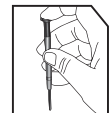

Metal Handle

SKU	OLD SKU	DESCRIPTION
STHT66039-8	1-66-039	Metal - 6pcs set

7 PIECES SET - VDE SCREWDRIVERS



- 3.0 x 100mm
4.0 x 100mm
5.5 x 125mm
6.5 x 150mm
- +** PH1 x 80mm
PH2 x 100mm
- ⚡** 3.0 x 70mm

- Insulation directly injection-moulded around the blade
- Ergonomic, shock resistant, anti slip handle and for greater torque to be applied with less effort
- Each screwdriver is individually tested to 10,000V in a water bath for 10 SCEa

x7



Cr-Mo Bar

SKU	DESCRIPTION
STHT65980-8	VDE Screwdriver 7 pcs set Flat 3 x 100mm, 4 x 100mm, 5.5 x 125mm, 6.5 x 150mm, Phillips PH #1 x 80mm, PH #2 x 100mm

FATMAX® 6 PIECE FLAT/POZI VDE SCREWDRIVER SET



- Flat 2.5mm X 50mm, 3.5mm X 75mm, 5.5mm X 150mm
- Pozi PZ1 X 100mm, PZ2 X 125mm, Voltage tester

x6

SKU	Description
0-65-443	Insulated Flat / Pozi

FATMAX® 12 PIECE FLAT FLARED PHILLIPS POZI



- Flat 2.5mm X 50mm, 4mm X 100mm, 5.5mm X 150mm
- Flared 5.5mm X 100mm, 6.5mm X 30mm, 8mm X 150mm
- Phillips PH0 X 75mm, PH1 X 100mm, PH2 X 125mm
- Pozi PZ0 X 75mm, PZ1 X 100mm, PZ2 X 125mm

x12

SKU	Description
0-65-426	Flat / Flared / Phillips / Pozi

FATMAX® 6 PIECE FLAT FLARED POZI SET



- Flat 3.5mm X 75mm, 5.5mm X 150mm
- Flared 5.5mm X 100mm, 8mm X 150mm
- Pozi PZ1 X 100mm, PZ2 X 125mm

x6

SKU	Description
0-65-428	Flat / Flared / Pozi

PVC HANDLE - STANDARD SCREWDRIVERS

NEW
 STHT73055-8B
 STHT73056-8B
 STHT73057-8B
 STHT73058-8B



- Comfortable handle
- Chrome plated Cr-V bar resists corrosion
- Magnetic tips for secure grip on fasteners
- Color coordinated handles: red (standard)



SKU	DESCRIPTION
STHT73055-8B	6 X 150mm (Bulk) - 10 pcs / carton
STHT73056-8B	6 X 200mm (Bulk) - 10 pcs / carton
STHT73057-8B	6 X 250mm (Bulk) - 10 pcs / carton
STHT73058-8B	6 X 300mm (Bulk) - 10 pcs / carton

PVC HANDLE - STANDARD SCREWDRIVERS

NEW
 STHT69121-8
 STHT69175-8

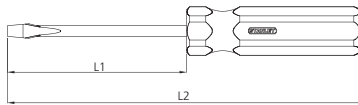
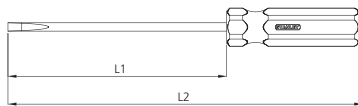
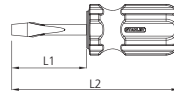

- Comfortable handle
- Chrome plated Cr-V bar resists corrosion
- Magnetic tips for secure grip on fasteners
- Color coordinated handles: red (standard)

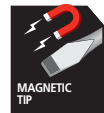

SKU	DESCRIPTION
STHT69121-8	8mm x 150mm
STHT69175-8	8mm x 250mm

PVC HANDLE - PHILLIPS SCREWDRIVERS

NEW
 STHT69141-8
 STHT69145-8
 STHT69146-8
 STHT69147-8

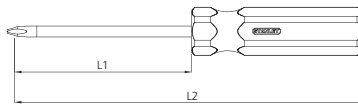
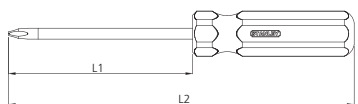
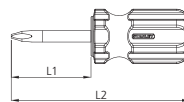

- Comfortable handle
- Chrome plated Cr-V bar resists corrosion
- Magnetic tips for secure grip on fasteners
- Color coordinated handles: blue (Phillips®)

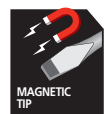

SKU	DESCRIPTION
STHT69141-8	PH #1 X 5mm X 100mm
STHT69145-8	PH #2 X 6mm X 100mm
STHT69146-8	PH #2 X 6mm X 200mm
STHT69147-8	PH #2 X 6mm X 250mm

PVC HANDLE - PHILLIPS SCREWDRIVERS

NEW
 100% PVC HANDLE
 100% CR-V BAR
 100% MAGNETIC TIP

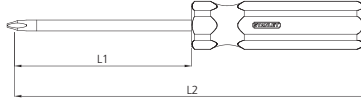
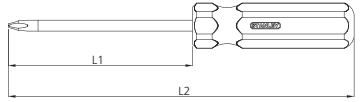
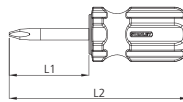

- Comfortable handle
- Chrome plated Cr-V bar resists corrosion
- Magnetic tips for secure grip on fasteners
- Color coordinated handles: blue (Phillips®)

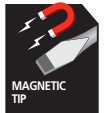

SKU	DESCRIPTION
STHT73069-8B	PH #1 X 100mm (Bulk) - 10 pcs / carton
STHT73070-8B	PH #1 X 150mm (Bulk) - 10 pcs / carton
STHT73071-8B	PH #1 X 200mm (Bulk) - 10 pcs / carton

SPARK DETECTING SCREWDRIVER



- Test range of 100~500V



ISOLATING PLASTIC HANDLE
 with safety indicator

SKU	DESCRIPTION
66-119	3 x 50 - Tester
66-120	5 x 100 - Tester

DOUBLE PINION HAND DRILL



SKU	DESCRIPTION
1-03-103	Length 315mm



DO YOU KNOW...

Which happened first?

- A. The invention of the light bulb.
- B. The manufacturing of STANLEY® screwdrivers.

Ans: B. STANLEY® manufactured screwdriver in 1870; Electric light bulb was invented in 1879.

STANLEY®

SAWS



Wood saws

Specialist Saws

Hack saws

Hack Saws Blades



SHAPE & SIZE OF SAW TEETH

The SHAPE and SIZE of the teeth determine the Speed of the saw and Smoothness of the cut.

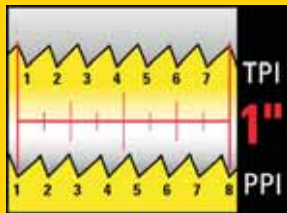

*Low No. TPI :



fast cut, coarse finish

*High No. TPI :



slower cut, smooth finish

* This is always denoted as the number of Teeth Per Inch (T.P.I.) and Points Per Inch (P.P.I.)

SET OF SAW TEETH

Teeth SET in Patterns:

Left, Right, Middle, Middle or Left x3,
Middle, Right x3

Middle Teeth have no set and act as Rakers
to clear out sawdust

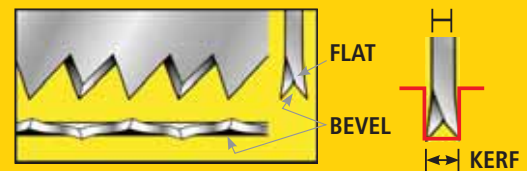

HACKSAWS



STANLEY® hacksaws have excellent safety features, making them some of the safest and most reliable tools on the market. Its excellent blade tension mechanism system plays a role in ensuring that less accidents happen on the job, creating a safe and tension-free work environment.

HACKSAW BLADES



Perfect for cutting metal or plastic piping, **STANLEY®** offers two different hacksaw blades with materials include High Speed Steel (HSS) and Bi-Metal. Bi-Metal hacksaw blades are made from a material that combines the segregated section of HSS and carbon steel.

JET CUT HEAVY DUTY - WOOD SAWS



- Induction hardened teeth stay sharper twice as long
- Bi-material handle screwed and ultrasonically welded for comfort and security

SKU	DESCRIPTION
2-15-283	450mm - 7 teeth/inch

JET CUT FINE FINISH - WOOD SAWS



- Induction hardened teeth stay sharper twice as long
- Bi-material handle screwed and ultrasonically welded for comfort and security

SKU	DESCRIPTION
2-15-594	380mm - 11 teeth/inch
2-15-595	450mm - 11 teeth/inch
2-15-599	500mm - 11 teeth/inch

LUCTADOR HANDSAW - WOOD SAWS



- High carbon steel blade
- Locked, polished and sharpenable teeth

SKU	DESCRIPTION
E-15470	450mm - 8 teeth/inch
E-15471	500mm - 8 teeth/inch
E-15472	550mm - 8 teeth/inch
E-15473	600mm - 8 teeth/inch

PROFESSIONAL HAND SAW - WOOD SAWS



- Specially shaped teeth for fast cuts
- Handle incorporates 45° and 90° square functionality

SKU	DESCRIPTION
E-15558	450mm - 8 teeth/inch
E-15559	500mm - 8 teeth/inch
E-15560	550mm - 8 teeth/inch

FATMAX® JAB SAW - SPECIALIST SAWS



- Triple bevelled toothing for 50% quicker easier cutting



SKU	DESCRIPTION
0-20-556	Jab Saw, 7 teeth per inch

RIGHT HANDLE LEVELLING SAW - SPECIALIST SAWS



- Resharpenable universal tothing, straight wood handle

SKU	DESCRIPTION
1-15-140	Length: 250mm ; Height: 55mm

ADJUSTABLE - HACKSAW



- Adjustable to 8", 10" and 12" blades
- Comfort pistol-grip handle with patented pattern for better grip and control
- Allows positioning of the blade at 90° for more versatility
- 101.6mm (4") throat depth

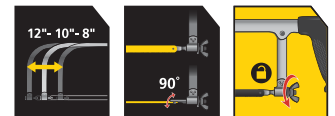

SKU	DESCRIPTION
E-15200	300mm

STANLEY HACKSAW



- Comfortable full handle with patented pattern for better grip and control
- Full grip protects knuckles
- Sturdy all steel painted frame
- 101.6mm (4") throat depth



SKU	DESCRIPTION
E-20206	300mm

HACKSAW FRAME - FIX



- 110mm / 4.375" Cutting depth - 100kg / 225 lbs Blade tension

SKU	DESCRIPTION
1-15-122	300mm / 12" fixed blade length

STRAIGHT HANDLE METAL MOUNT

- Supplied with a standard flexible LION blade



SKU	DESCRIPTION
1-15-123	Length: 510mm ; Blade : 300mm

JUNIOR HACKSAW - PLASTIC HANDLE



- Lever incorporated in the handle allowing a rapid change in the blade

SKU	DESCRIPTION
0-15-218	150mm - Plastic Handle

MINI HACKSAW



- Durable solid plastic construction
- Ideal for hard-to-reach places
- 10" blades

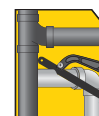

SKU	OLD SKU	DESCRIPTION
STHT20807-8	0-20-807	Blade Length: 250mm

HACKSAW BLADES - BI-METAL LASER



SKU	MATERIAL	BOX QTY	DESCRIPTION
1-15-557	Bi-Metal Laser	Box of 100 pc	18 teeth/inch - 300 mm
1-15-558	Bi-Metal Laser	Box of 100 pc	24 teeth/inch - 300 mm

HACKSAW BLADES



SKU	MATERIAL	BOX QTY	DESCRIPTION
0-15-842	Hacksaw Blades - Lion	Packaging of 2 pc	24 teeth/inch- 300 mm
1-15-842	Hacksaw Blades - Lion	Box of 100 pc	24 teeth/inch- 300 mm

STANLEY®

PLANES, SURFORMS & CHISELS



Metal Planes

Shoulder planes

Specific planes

Block Planes

Plane Irons

Surforms

Chisels



SURFORM®

The best known feature of the Surform® range is its compact and lightweight molded body. Surform® shavers are tough and have sidecut teeth for shaving down corners. The shaver's simple click-on blade replacement makes it easy to replace the blade, ensuring that there will be no holdups while getting the job done.

HOW TO USE SURFORM® TOOLS



For **FAST CUTTING**, use the tool at an angle of about 30° in the direction of the cut



For **SMOOTHING** and **FINISHING**, use the tool parallel to the direction of the cut



TERMINOLOGY OF CHISEL

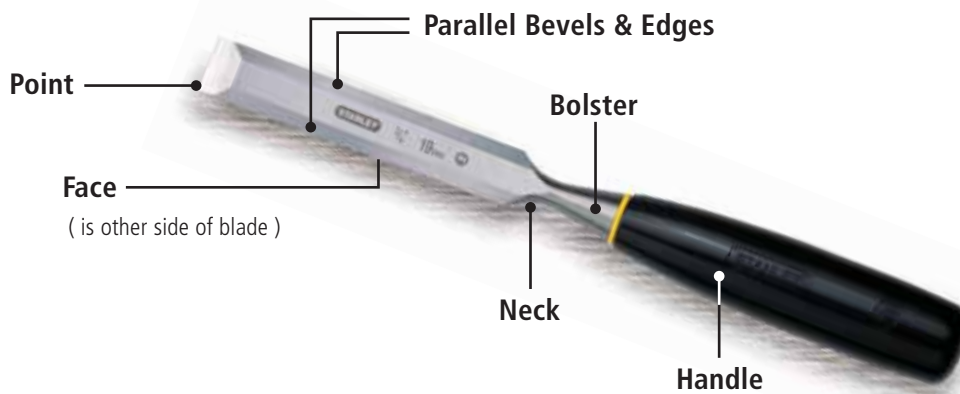

PRECISION REMOVAL AND PARING OF WOOD

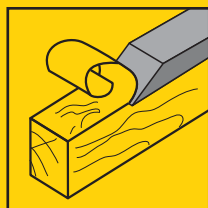

Cutting and carving

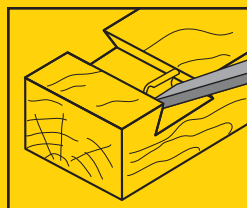

Dovetail joints

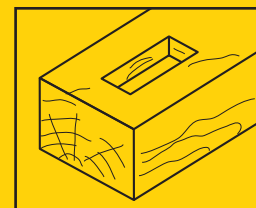

Mortise joints

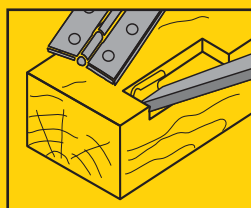

Mortise locks & hinges

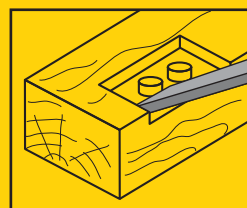

Trim dowels

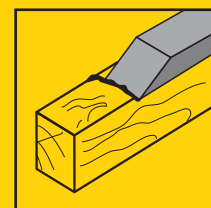

Remove excess glue

METAL PLANES - BAILEY



SKU	DESCRIPTION
1-12-003	3 - 240mm Length
1-12-004	4 - 250mm length
1-12-005	5 - 355mm length
1-12-006	6 - 455mm length

METAL PLANES - HANDYMAN BENCH PLANES



SKU	DESCRIPTION
1-12-203	240mm
1-12-204	250mm
1-12-205	355mm

METAL PLANES - PLANES SB



SKU	DESCRIPTION
1-12-033	210mm
1-12-034	245mm

N°78 REBATE PLANE - SHOULDER PLANES



SKU	DESCRIPTION
1-12-078	254mm

SPOKESHAVES 151- SPECIFIC PLANES



SKU	DESCRIPTION
1-12-151	Round base
1-12-152	Flat base

BLOCK PLANES



SKU	DESCRIPTION
1-12-102	102 Block Plane 140mm
1-12-116	110 Block Plane 180mm
1-12-220	Block Plane 220 - Adjustable 180mm
1-12-060	Block Plane Fully Adjustable Low Angle 150mm
1-12-020	Smoothing Block Plane - Fully Adjustable 160mm

PLANES IRONS



SKU	TYPE	DESCRIPTION
1-12-312	Irons for Bailey Planes	45mm
0-12-313	Irons for Bailey Planes	50mm
1-12-313	Irons for Bailey Planes	50mm
0-12-315	Irons for Bailey Planes	60mm
1-12-315	Irons for Bailey Planes	60mm
0-12-508	Iron for Block Plane Adjustable (1-12-020 and 1-12-220)	40mm

SHARPENING SYSTEM FOR CHISELS AND PLANE IRONS



- Permits sharpening of all plane irons and scissors between 3 mm and 60 mm in width

SKU	DESCRIPTION
0-16-050	Angle setting gauge with preset markings – 25°, 30° or 35°

SURFORMS



SKU	TYPE	DESCRIPTION
5-21-122	Metal Body	Flat Convertible 255mm blade
5-21-296	Metal Body	File 255mm blade

SURFORMS



SKU	TYPE	DESCRIPTION
5-21-103	Moulded Body	Flat 55mm blade

SURFORMS

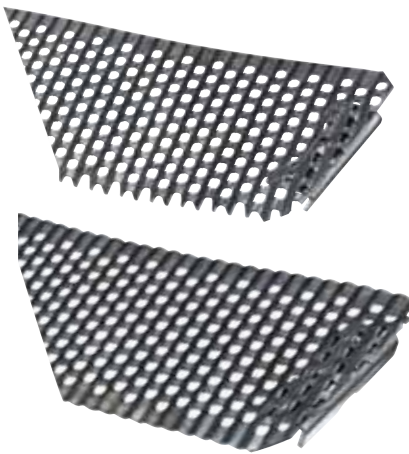

SKU	TYPE	DESCRIPTION
5-21-293	Standard Cut Blade	250mm - Fits: 21-122, 21-295, 21-296, 21-103
5-21-393	Fine Cut Blade	250mm

DYNAGRIP™ WOOD CHISELS



- Forged high carbon steel – reassurance of strength and durability
- Pre-sharpened blade – ready for immediate use



SKU	TYPE	DESCRIPTION
0-16-870	Individual Chisel	6mm
0-16-873	Individual Chisel	12mm
0-16-877	Individual Chisel	18mm
0-16-880	Individual Chisel	25mm
0-16-881	Individual Chisel	32mm
2-16-885	Chisel set	5 pieces 6/12/18/25/32

5002 BLUE HANDLE WOOD CHISELS

- Solid Polypropylene Handle for durability
- Lacquered blade prevents from corrosion



SKU	DESCRIPTION
0-16-535	6mm
0-16-537	8mm
0-16-539	10mm
0-16-540	12mm
0-16-542	14mm
0-16-545	18mm
0-16-547	16mm
0-16-548	20mm
0-16-549	22mm
0-16-551	25mm
0-16-554	32mm
0-16-558	38mm
0-16-560	50mm
0-16-128	3 pieces 12/18/25
0-16-129	4 pieces 6/12/18/25
0-16-130	6 pieces 6/12/18/25 Oil - Sharpening Stone

STANLEY®

DEMOLITION & HAMMERS



Ripping Bars

Ball Pein Hammers

Specific hammers

Nail-pulling hammers



STANLEY®

TERMINOLOGY OF HAMMER

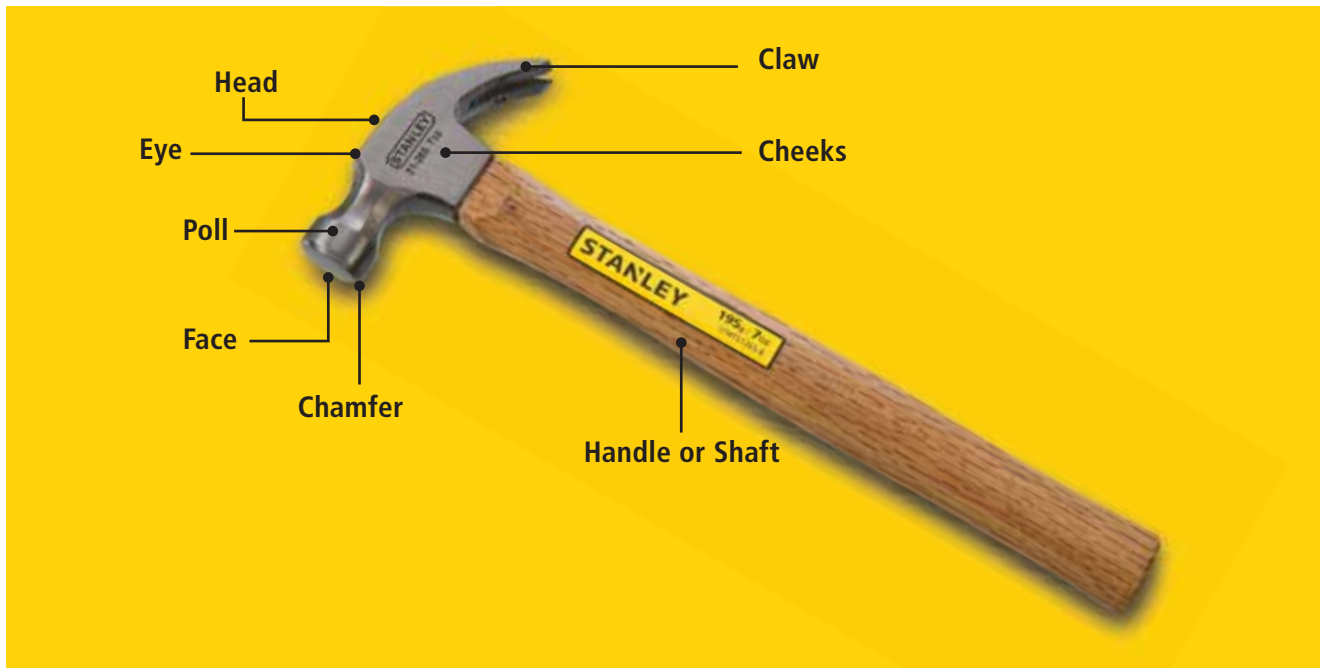

TYPES OF HAMMERS

*Hammers are usually described by their head shape and head weight.



CLAW HAMMER

Driving and pulling common nails

*NOT masonry nails



BALL PEIN HAMMER

Used by engineers to strike a cold chisel when cutting metal or to bend and shape metal



FACE MALLET

Striking metal against metal without surface damage



RUBBER MALLET

For use on soft surfaces that need to be protected such as wooden floors, tiles and furniture surfaces

RIPPING BARS



SKU	TYPE	DESCRIPTION
1-55-156	Forged and tempered steel Crowbar	60 cm
1-55-157	Forged and tempered steel Crowbar	70 cm

BALL PEIN HAMMERS



- Ball end used for riveting, and poll used for normal striking
- The hammer head is attached with two wedges for improved durability
- Exclusive rim temper reduces incidences of chipping or spalling

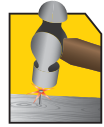

SKU	TYPE	DESCRIPTION
STHT54189-8	Wooden Handle	200grs - 8 oz
STHT54190-8	Wooden Handle	300grs - 12 oz
STHT54191-8	Wooden Handle	500grs - 16 oz
54-192	Wooden Handle	700grs - 24 oz
54-193	Wooden Handle	1000grs - 32 oz

SPECIFIC HAMMERS



- Rubber head helps minimize marring and surface damage
- Tough rubber head molded to a wood handle

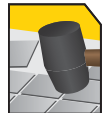

SKU	TYPE	DESCRIPTION
STHT57527-8	Rubber Mallets	450 grs - 16 oz
STHT57528-8	Rubber Mallets	680grs - 24 oz

NAIL-PULLING HAMMERS

• Different materials and grips to suit a variety of users and jobs

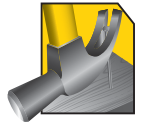

SKU	OLD SKU	TYPE	DESCRIPTION
1-51-031	-	Steelmaster Claw Hammer - 330mm	450 grs - 16 oz
1-51-033	-	Steelmaster Claw Hammer - 330mm	570grs - 20 oz
STHT51071-8	-	Fiberglass Nail Hammers - 335mm	450 grs - 16 oz
STHT51072-8	-	Fiberglass Nail Hammers - 335mm	570grs - 20 oz
STHT51081-8	51-081	Jacketed Steel Handle Hammers - 335mm	450 grs - 16 oz
STHT51082-8	51-082	Jacketed Steel Handle Hammers - 335mm	570grs - 20 oz
STHT51271-8	-	Wood Handle Hammer - Octogonal Head - 330mm	450 grs - 16 oz
STHT51274-8	-	Wood Handle Hammer - Octogonal Head - 335mm	570grs - 20 oz



STANLEY®

CLAMPS & PLIERS



Vices

Pincers & Snips

Shears

Scissors

Pliers



THE COMPREHENSIVE RANGE OF PLIERS

Whatever the task is, there is a **STANLEY®** pliers to help. Manufactured from quality steel, the range of pliers are built for high performance in any situation.

The range of options include linesman, combination, diagonal cutter, long nose, bent nose, wire stripper, slip joint, groove joint, and locking pliers.

PLIERS Available as:

Linesman, combination, long nose, bent nose, wire stripper, slip joint & groove joint variants



LOCKING PLIERS Available as:

Curved jaw, Straight jaw, Long nose, Welding, Sheet metal or 'C' clamp variants



LINESMAN



LONG NOSE



SLIP JOINT



DIAGONAL CUTTER



WIRE STRIPPERS



CURVED JAW



ANSI
American National Standards Institute

VDE PLIERS

STANLEY® is proud to be one of the market leaders in providing VDE solutions. Tested and proven, these tools either meet or exceed industry standards and can ensure safety when working with live equipment up to 1000VAC or 1500VDC.



PIPE PLIERS

The pipe pliers by **STANLEY®** boast a solid cast iron body and jaw forged with chrome molybdenum steel. Tough materials are used to ensure that the entire range provides users with great performance and durability.



ADJUSTABLE WRENCH

Every wrench produced by **STANLEY®** exceeds ANSI standards. Adjustable jaw design allows tool to grip many fastener sizes. Knurl adjusting mechanism is available for quick and precise adjustments.



BENCH VICES - MAXSTEEL® HEAVY DUTY



- Cast iron construction for strength and durability
- Chrome-plated to resist corrosion

SKU	CLAMPING CAPACITY	THROAT DEPTH
1-83-067	125mm/5"	85mm
1-83-068	150mm/6"	95mm

FATMAX® AVIATION SNIPS : STRAIGHT - RIGHT & LEFT CUT

- Cuts up to 18 gauge (1.2mm) cold-rolled steel or 23 gauge (0.7mm) stainless-steel
- Forged chrome molybdenum steel cutting blades for strength, durability and long cutting life
- Serrated cutting blades provides a sturdy bite and helps prevent material from slipping during use
- Latch design allows for a quick single handed operation
- Adjustment-free fasteners prevent loosening of the blades
- Color-coded, slip-resistant bi-material grip for comfort and control
- Meets or exceeds ANSI standards

> STRAIGHT AND LONG CUT



SKU	DESCRIPTION
2-14-563	250mm - Straight Cut

> OFFSET - LEFT CUT



SKU	DESCRIPTION
2-14-562	250mm - Left Cut

> OFFSET -RIGHT CUT



SKU	DESCRIPTION
2-14-564	250mm - Right Cut

MAXSTEEL & TRADE - STRAIGHT PATTERN TIN SNIPS



- Cuts up to 20 gauge (0.91mm) cold-rolled steel or 23 gauge (0.72mm) stainless-steel
- Durable fully-polished steel blades are forged to stay sharp for long cutting life



SKU	OLD SKU	DESCRIPTION
STHT14556-8	2-14-556	250mm
STHT14558-8	2-14-558	300mm

SHEARS & SCISSORS



SKU	DESCRIPTION
STHT0-14103	Titanium coated blade – Bi-material handle
STHT0-14102	Cuts: Twine, heavy fabric, strapping and other heavy duty materials

4 PIECES SET MAXSTEEL VDE PLIERS





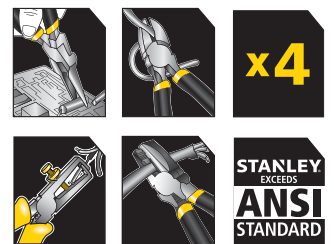



- Safe live line working to 1,000V
- Compliant to EN60900, IEC/CEI900, VDE0680
- DIN / ASO / ANSI compliant



SKU	DESCRIPTION
4-84-489	Comb. pliers 165 mm/Half rd long nose -160 mm/Diag. wire cutting-175 mm/Wire stripper-170 mm

MAXSTEEL VDE PLIERS

- Safe live line working to 1,000V
- Compliant to EN60900, IEC/CEI900, VDE0680 • DIN / ASO / ANSI compliant

	SKU	DESCRIPTION
	0-84-001	Combination Pliers - 185mm
	0-84-002	Combination Pliers - 200mm
	0-84-003	Diagonal Cutting Pliers - 175mm
	0-84-004	Diagonal Cutting Pliers - 195mm
	0-84-016	End Cutters 1000V - 165mm
	0-84-006	Long Nose Pliers - 180mm
	0-84-007	Long Nose Pliers - 210mm
	0-84-009	Narrow Diagonal Pliers - 160mm
	0-84-010	Wire Stripper - 160mm
	0-84-294	Waterpump Maxsteel Pliers - 255mm

3 PIECES SET - BIMATERIAL PLIERS



- Forged carbon steel jaws and handle for long life
- Bi-material handles for comfort and grip even with oily hands



SKU	DESCRIPTION
6-97-043	Universal Bimaterial, Water Pump, Diagonal

3 PIECES SET - BIMATERIAL PLIERS

- Forged carbon steel jaws and handle for long life
- Bi-material handles for comfort and grip even with oily hands





SKU	DESCRIPTION
4-84-485	3 pcs set :Combi, Diagonal, Long Nose

3 PIECES SET - BIMATERIAL PLIERS

- Forged carbon steel jaws and handle for long life
- Bi-material handles for comfort and grip even with oily hands



	SKU	DESCRIPTION
	0-84-072	Curved Long-Nosed Pliers - 200mm
	0-84-077	Front Cutting Pliers - 150mm

BIMATERIAL PLIERS

- Forged carbon steel jaws and handle for long life
- Bi-material handles for comfort and grip even with oily hands

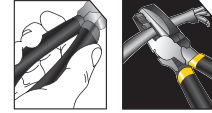



	SKU	OLD SKU	DESCRIPTION
	84-167		End nipping pliers 8 inch - 200mm
	84-270		End nipping pliers 6 inch - 150mm
	STHT84053-8	0-84-053	Straight Long-Nosed Pliers - 150mm
	0-84-625		Straight Long-Nosed Pliers - 200mm
	0-84-076		Water Pump Pliers - 240mm
	0-84-075		Wire Stripper - 150mm
	0-84-054		Diagonal Cutting Pliers - 150mm
	0-84-622		Diagonal Cutting Pliers - 200mm
	0-84-055		Universal Bimaterial Slip Joint - 180mm
	0-84-056		Universal Bimaterial Slip Joint - 200mm
	0-84-623		Universal Bimaterial Slip Joint - 150mm

HEAVY DUTY PLIERS

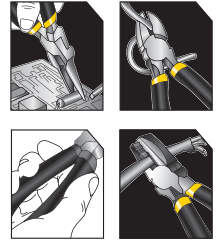
- Made In Chrome Vanadium Steel
- Heavy Duty Finish, resistant Bicolor handle



	SKU	DESCRIPTION
	84-915	Heavy Duty Long Nose Pliers - 150 mm
	84-916	Heavy Duty Diagonal Cutting Pliers - 150 mm
	84-919	Heavy Duty Universal Pliers - 200 mm

STANLEY PLIERS

- Heat treated carbon steel forging for long life
- Comfort grip handles

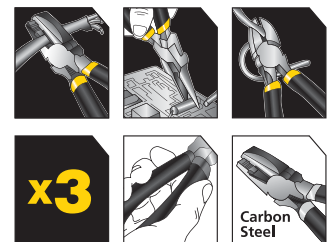

SKU	DESCRIPTION
0-84-114	3 pieces Set Stanley® Plier - 150 mm

STANLEY PLIERS

- Heat treated carbon steel forging for long life
- Comfort grip handles

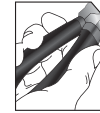

SKU	DESCRIPTION
0-84-101	Long Nose Plier Stanley® - 150mm
0-84-102	Long Nose Plier Stanley® - 200mm

STANLEY PLIERS

- Heat treated carbon steel forging for long life
- Comfort grip handles



SKU	DESCRIPTION
0-84-112	Combination Plier - 180mm
0-84-113	Combination Plier - 200mm

STANLEY PLIERS

- Heat treated carbon steel forging for long life
- Comfort grip handles



SKU	DESCRIPTION
0-84-105	Diagonal Cutting Plier - 150mm
0-84-108	Diagonal Cutting Plier - 180mm

STANLEY PLIERS

- Heat treated carbon steel forging for long life
- Comfort grip handles



SKU	DESCRIPTION
0-84-110	Waterpump Plier - 250mm
0-84-111	Waterpump Plier - 300mm

STANLEY PLIERS

- Heat treated carbon steel forging for long life
- Comfort grip handles

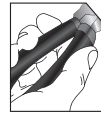

SKU	OLD SKU	DESCRIPTION
STHT84271-8		Circlip Plier Straight Exterior Type 7" - 178 mm
STHT84272-8		Circlip Plier Bent Exterior Type · 7" - 178 mm
STHT84273-8	84-273	Circlip Plier Straight Interior Type · 7" - 178 mm
STHT84274-8	84-274	Circlip Plier Bent Interior Type · 7" - 178 mm

LOCKING PLIERS

- General purpose pliers ideal for a wide range of applications



SKU	DESCRIPTION
0-84-816	C Clamp Locking Pliers - 185mm

LOCKING PLIERS - CURVED JAW

- General purpose pliers ideal for a wide range of applications



STHT84369-8



0-84-808
0-84-809

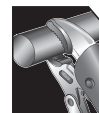

SKU	OLD SKU	DESCRIPTION
STHT84369-8	1-84-369	Curved Jaw Locking Pliers with Bi-material Handle - 250mm
0-84-808		Traditional Curved Jaw Locking Pliers - 185mm
0-84-809		Traditional Curved Jaw Locking Pliers - 225mm

LOCKING PLIERS - STRAIGHT JAW

- General purpose pliers ideal for a wide range of applications



SKU	DESCRIPTION
0-84-811	225mm
0-84-810	190mm

LOCKING PLIERS - LONG NOSE PRO

- General purpose pliers ideal for a wide range of applications



SKU	OLD SKU	DESCRIPTION
STHT84389-8	84-389	9-1/2 in Length (240 mm)

LOCKING PLIERS - SHEET METAL

- General purpose pliers ideal for a wide range of applications



SKU	OLD SKU	DESCRIPTION
STHT84398-8	84-398	8 in Length (203 mm)

LOCKING PLIERS - PRO EURO STYLE WATER PUMP

- General purpose pliers ideal for a wide range of applications

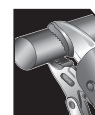

SKU	DESCRIPTION
84-015	10 in Length (254 mm)

PINCERS

	SKU	DESCRIPTION
	84-282	Tower Pincers - 254 mm
	2-84-181	Mechanic's Pincers - 250mm
	2-84-184	Carpenter's Pincers - 225mm

SPECIFIC PLIERS - ENGLISH SNIPS



SKU	DESCRIPTION
14-164	Tinsnips 10 inches
14-165	Tinsnips 12 inches
14-166	Tinsnips 14 inches

SPECIFIC PLIERS - BOLT CUTTERS



SKU	DESCRIPTION
14-318	450mm
14-324-23	600mm
14-330	750mm
14-336	900mm

SPECIFIC PLIERS - PVC PIPE CUTTER



SKU	DESCRIPTION
14-442	42mm

SPECIFIC PLIERS - CABLE CUTTER

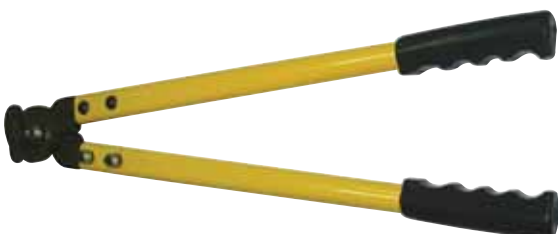

SKU	DESCRIPTION
84-629	125mm
84-630	250mm
84-632	500mm

SPECIFIC PLIERS - CRIMPING PLIERS



84-223-22



84-253

SKU	DESCRIPTION
84-223-22	Crimping Plier - 230 mm
84-253	Crimping Pliers Set - 230mm

SPECIFIC PLIERS - WIRE STRIPPERS



SKU	DESCRIPTION
84-214	130mm

TUBING CUTTERS

- Tubing cutters for cutting copper/plastic tubing



SKU	DESCRIPTION
93-020-22	3- 28mm
93-028	6- 64mm

MULTI TOOLS - 29 TOOLS IN 1



- Ergonomic handle with Stanley® patented design
- Stainless steel
- Includes 11 screwdriver bits and organizer
- Includes carrying case
- Long Nose Pliers, Bent Nose Pliers, Wire Cutter Bit, Adapter Standard Bit, Square Bit, Torx Bit, Large Knife, Standard Screwdriver, Bottle Opener, Small Knife, Hook Remover, Can Opener, Can Opener Blade



SKU	DESCRIPTION
94-806	29 in 1 Multitool Plier

MULTI TOOLS - 21 TOOLS IN 1



- Stainless steel
- Includes carrying case
- Long Nose plier, Bent Plier, Wire Cutter, Large Knife, Can Opener, Large Knife, Standard Screwdriver, Bottle Opener, Small Knife, Hook Remover, Can Opener Blade

SKU	DESCRIPTION
94-807	21 in 1 Multitool Plier

MULTI TOOLS - 12 TOOLS IN 1



- Long nose pliers, Curve jaw pliers, Wire cutter, Saw, Phillips® screwdriver, Standard screwdrivers (1/4", 5/16", 1/8"), Small knife, Large knife, Bottle opener, File



SKU	DESCRIPTION
0-84-519	12 tools in 1 Multitool Plier

MULTI TOOLS - MINI SET



- Offering a practical mini version of Multi-Tool: Saw, Knife, Ph1 Screwdriver, Flat screwdriver, Can opener, File, & Pliers

SKU	DESCRIPTION
STHT0-70648	Mini Multitool

MULTI TOOLS - 2 SET PACK

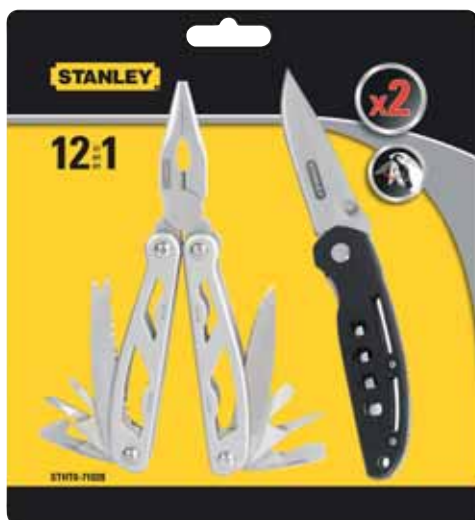

SKU	DESCRIPTION
STHT0-71028	2 Pack Multi Tool & Pocket Knife Combo

MULTI TOOLS - 3 SET PACK



SKU	DESCRIPTION
STHT0-71029	3 Pack multi tool and knife set



STANLEY®

AUTOMOTIVE TOOLS



Spanners

Mixed Socket Sets

Wrenches

Ratchet

Angled Socket Wrenches

Hex Keys

Wrenches Sets

Pipe Wrench

Sockets & Socket Sets

Air Tools



OPEN-ENDED SPANNERS - FATMAX® 12 PIECES SET (METRIC)



x12

SKU	DESCRIPTION
1-95-770	06x07 - 08x09 - 10x11 - 12x13 - 14x15- 16x17 - 18x19 - 20x22 - 21x23 - 24x26 - 25x28 - 30x32mm

COMBINATION SPANNERS - SET OF MAXI DRIVE PLUS



x8

SKU	DESCRIPTION
4-87-054	8, 10, 11, 13, 14, 15, 17, 22 mm

SET OF 6 MAXI DRIVE PLUS COMBINATION RATCHET SPANNERS



x6

SKU	DESCRIPTION
4-89-907	10, 12, 13, 16, 17, 19 mm

ADJUSTABLE WRENCHES



SKU	DESCRIPTION
87-430-1-23	100mm
STMT87431-8	150mm
STMT87432-8	200mm
STMT87433-8	250mm
STMT87434-8	300mm
STMT87435-8	375mm
1-87-371	450mm
97-797	600mm

10 PIECES SET 6X6 POINT ANGLED SOCKET WRENCHES



x10

SKU	DESCRIPTION
1-17-387	8-10-11-12-13-14-16-17-18-19 mm

COMBINATION WRENCHES



- Chrome vanadium steel
- Matt finish
- Anti-slip open ends
- Maxi Drive® ring



SKU	DESCRIPTION
STMT72803-8	6 mm
STMT72805-8	8 mm
STMT72807-8	10 mm
STMT72809-8	12 mm
STMT72810-8	13 mm
STMT72811-8	14 mm
STMT72812-8	15 mm
STMT72814-8	17 mm
STMT72816-8	19 mm
STMT72817-8	20 mm
STMT72818-8	21 mm
STMT72819-8	22 mm
STMT72821-8	24 mm
STMT72824-8B	27 mm (Bulk Pack of 10 pcs)
STMT72827-8B	30 mm (Bulk Pack of 10 pcs)
STMT72828-8B	32 mm (Bulk Pack of 10 pcs)

GEAR WRENCHES

- Chrome vanadium steel
- Mirror finish
- Anti-slip open ends
- 5° increment



SKU	DESCRIPTION
STMT89934-8B	8 mm (Bulk Pack of 10 pcs)
STMT89936-8B	10 mm (Bulk Pack of 10 pcs)
STMT89937-8B	12 mm (Bulk Pack of 10 pcs)
STMT89938-8B	13 mm (Bulk Pack of 10 pcs)
STMT89939-8B	14 mm (Bulk Pack of 10 pcs)
STMT89940-8B	15 mm (Bulk Pack of 10 pcs)
STMT89941-8B	16 mm (Bulk Pack of 10 pcs)
STMT89944-8B	19 mm (Bulk Pack of 10 pcs)

6 PIECES COMBINATION WRENCH SET



x6



STANLEY
EXCEEDS
ANSI
STANDARD

SKU	DESCRIPTION
STMT73648-8	10;12;14;17;19;21 mm

8 PIECES COMBINATION WRENCH SET



x8



STANLEY
EXCEEDS
ANSI
STANDARD

SKU	DESCRIPTION
STMT73649-8	8;10;11;12;13;14.17;19 mm

14 PIECES COMBINATION WRENCH SET



x14



STANLEY
EXCEEDS
ANSI
STANDARD

SKU	DESCRIPTION
STMT73647-8	8;9;10;11;12;13;14;15;16;17;18;19;22;24 mm

23 PIECES COMBINATION WRENCH SET



x23



SKU	DESCRIPTION
STMT33650-8	6;7;8;9;10;11;12;13;14;15;16;17;18;19;20;21;22;23;24;25;27;30;32 mm

6 PIECES DOUBLE OPEN END WRENCH SET



x6



SKU	DESCRIPTION
STMT73663-8	6x7;8x10;11x13;12x14;17x19;21x23 mm

6 PIECES DOUBLE RING WRENCH SET



x6



SKU	DESCRIPTION
STMT73664-8	8x10;11x13;12x14;17x19;21x23; 22x24 mm

SOCKET SETS

	SKU	TYPE	DESCRIPTION
	2-85-582	17-Piece 1/4" Micro Tough Socket Set	4- 5- 5.5-6- 7- 8- 9- 10- 11- 12- 13 mm
	1-87-065	15-Piece 1/2" Set	8- 10-11- 12- 13- 14- 15- 16- 17- 19- 22 mm
	86-477	27 Piece Socket Set - 1/2" Drive	10-11-12-13-14-15-16-17-18-19-20- 21-22-23-24-25-26-27-30-32mm
	2-85-584	29-Piece 1/2" Micro Tough Socket Set	8- 9-10- 11- 12- 13- 14- 15- 16- 17- 18- 19- 20- 21- 22- 23- 24- 26- 28- 29- 30- 32 mm
	1-94-658	50-Piece 1/4 & 1/2 Uptier Socket Set	7 hex key set : 1.5 to 6 mm / 1/4" Sq Drive sockets : 4 to 13 mm / 1/2" Sq Dr. sockets: 10 to 30 mm

SOCKET SETS

	SKU	TYPE	DESCRIPTION
	1-86-789	52-Piece 1/4" & 1/2" Socket Set	11 1/4" Hex sockets: 4 to 13 mm 13 1/2" Hex sockets: 10 to 32 mm.
	STMT71648	40pcs 1/4-3/8 6pts SAE/metric socket set	<ul style="list-style-type: none"> • 3/8" ratchet, quick release • 3/8" EXTENSION: 75MM • COUPLER 3/8" TO 1/4" • 3/8" 6PTS SOCKETS (7/16- 1/2- 9/16- 5/8- 11/16) (13-14-15-16-17) • 1/4" 6PTS SOCKETS (5/32-3/16- 7/32- 1/4- 9/32- 5/16- 11/32- 3/8- 1/2- 7/16) (4-5-6-7-8-9-10-11-12MM) • 1/4" SPINNER HANDLE • 1/4" BIT HOLDER • 1/4" BITS (PH 1-2-3 - SLOT 3-4-5M)
	STMT71650	60pcs 1/4-3/8 6pts SAE/metric socket set	<ul style="list-style-type: none"> • 3/8" ratchet, quick release • 3/8" EXTENSION: 75MM • COUPLER 3/8" TO 1/4" • 3/8" 6PTS SOCKETS (1/4- 5/16- 13/16- 3/8 -7/16- 1/2- 9/16- 5/8- 11/16- 3/4) (8-9-10-11-12-13-14-15-17) (3/8" SPARK PLUG SOCKET 5/8) • 1/4" 6PTS SOCKETS (5/32-3/16- 7/32- 1/4- 9/32- 5/16- 11/32- 3/8- 1/2- 7/16- 13/32- 9/16) (4-4.5-5-5.5-6-7-8-9-10-11-12-13MM) • 1/4" EXTENSION 50MM • 1/4" SPINNER HANDLE • 1/4" BIT HOLDER • 1/4" BITS (PH 0-1-2-3) - (SLOT 3-4-5MM) (HEX 3/32-1/8-5/32)
	STMT71651	85pcs 1/4-3/8 6PTS std and long SAE/metric socket sets	<ul style="list-style-type: none"> • 72 teeth 3/8" ratchet, quick release • 72 teeth 1/4" ratchet, quick release • 3/8" EXTENSION: 75MM • 3/8" SPARK PLUG SOCKET 5/8 • 3/8" 6PTS STANDARD SOCKETS (1/4-5/16-3/8-7/16-1/2-9/16-5/8-11/16) (6-7-8-9-10-11-12-13-14-15-17) • 1/4" 6PTS STANDARD SOCKETS (5/32-3/16- 7/32- 1/4- 9/32- 5/16- 11/32- 3/8- 1/2- 7/16- 9/16) (4-4.5-5-5.5-6-7-8-9-10-11-12-13-14MM) • 1/4" 6PTS LONG SOCKETS (5/32-3/16- 7/32- 1/4- 9/32- 5/16- 11/32- 3/8- 1/2- 7/16) (4-5-6-7-8-9-10-11-12-13MM) • 1/4" EXTENSION 75MM • 1/4" SPINNER HANDLE • 1/4" BIT HOLDER • 1/4" BITS (PH 0-1-2-3) - (SLOT 3-4-5MM) (HEX 3/32-1/8-5/32") - (TORX/SQUARE 5pcs)

SOCKET SETS

	SKU	TYPE	DESCRIPTION
 	<p>STMT71653</p>	<p>145pcs 1/4-3/8 - std/ long - metric/SAE sockets wrenches - hex keys - bits</p>	<ul style="list-style-type: none"> • 3/8" ratchet, quick release • 1/4" ratchet, quick release • 3/8" EXTENSION: 75MM • 3/8" SPARK PLUG SOCKET 5/8 • 3/8" 6PTS STANDARD SOCKETS (1/4-5/16-3/8-7/16-1/2-9/16-5/8-11/16) (6-7-8-9-10-11-12-13-14-15-16-17) • 3/8" 6PTS LONG SOCKETS (3/8-7/16-1/2-9/16) (10-12-13-14MM) • 1/4" 6PTS STANDARD SOCKETS (5/32-3/16-7/32-1/4-9/32-5/16-11/32-3/8-1/2-7/16-9/16) (4-4.5-5-5.5-6-7-8-9-10-11-12-13-14MM) • 1/4" 6PTS LONG SOCKETS (5/32-3/16-7/32-1/4-9/32-5/16-11/32-3/8-1/2-7/16-9/16) (4-5-6-7-8-9-10-11-12-13-14MM) • 1/4" EXTENSION 75MM • 1/4" SPINNER HANDLE • 1/4" BIT HOLDER • 1/4" BITS - 30pcs • 1/4" NUT BITS (7/32-1/4-5/16-11/32-3/8-7/16) (6-7-8-10MM) • Combination wrenches (3/8-1/2-9/16-5/8) - (10-11-12-13MM) • Hexagonal keys (1/16-5/64-3/32-1/8-5/32-3/16-7/32-1/4) (1.5-2-2.5-3-3.5-4-5-6MM)
	<p>STMT72794-8</p>	<p>46pcs 1/4 6pts metric socket set</p>	<p>72 teeth 1/4" ratchet, quick release and comfortable handle</p> <ul style="list-style-type: none"> • 1/4" EXTENSIONS : 50 and 100MM • 1/4" FLEXIBLE EXTENSION • 1/4" UNIVERSAL JOINT • 1/4" SLIDING TEE • 1/4" SPINNER HANDLE • 1/4" BIT SOCKETS (HEX 3-4-5-6-7-8MM) (TORX T8-T10-T15-T20-T25-T30-T40) (PH 1-2-3) (PZ 1-2-3) (SLOT 4-5-5-7MM) • 1/4" 6 PT STANDARD SOCKET (4-4.5-5-5.5-6-7-8-9-10-11-12-13-14MM) • Hex keys 1.5-2-2.5-3MM
	<p>STMT72795-8</p>	<p>24pcs 1/2 6pts metric socket set</p>	<ul style="list-style-type: none"> • 1/2" Stanley P9 ratchet • 1/2" EXTENSIONS : 130 and 250MM • 1/2" UNIVERSAL JOINT • 1/2" SLIDING TEE • 1/2" SPARK PLUG SOCKETS 21 MM • 1/2" 6 PT STANDARD SOCKET • 10-11-12-13-14-15-16-17-18-19-20-21-22-23-24-27-30-32MM

1/2" PEAR HEAD RATCHET P9



- ASME B107.10M-2005, ISO 3315, DIN 3122, ISO 1174-1
- Socket safety lock
- Lever reverse: rotation direction displayed
- Chrome vanadium steel
- Ergonomic bimaterial handle
- Quick release button



SKU	DESCRIPTION
STMT95893-8B	1/2" SD PEAR HEAD RATCHET P9

1/4" PEAR HEAD RATCHET P9



- ASME B107.10M-2005, ISO 3315, DIN 3122, ISO 1174-1
- Socket safety lock
- Lever reverse: rotation direction displayed
- Chrome vanadium steel
- Ergonomic bimaterial handle
- Quick release button



SKU	DESCRIPTION
STMT95895-8B	1/4" SD PEAR HEAD RATCHET P9

HEX KEYS



SKU	TYPE	DESCRIPTION
4-69-262	7-pieces Metric Hexagonal Male Key Sets	1.5- 2- 2.5- 3- 4- 5- 6 mm
4-69-263	8-pieces Male Torx Key Set	T9- T10- T15- T20- T25- T27- T30- T40

HEX KEYS



SKU	TYPE	DESCRIPTION
0-69-253	10 pieces Straight Male Elbow Hex Key Sets	1.5- 2- 2.5- 3- 4- 5- 5.5- 6- 8- 10 mm
0-69-256	9 pieces Long Spherical Head Male Spanner Set	1.5- 2- 2.5- 3- 4- 5- 6- 8- 10 mm

10 PIECES HEX KEY SET RING



- ANSI B18.3.2M-1979 ,GGG-K-275D
- Cr-V steel
- Anti-corrosion treatment
- Black Phosphate finish



SKU	OLD SKU	DESCRIPTION
STMT69213-8	69-213	1.5/2/2.5/3/4/5/5.5/6/8/10 mm
69-230	-	1/16, 5/64, 3/32, 1/8, 5/32, 3/16, 7/32, 1/4, 5/16, 3/8"

9 PIECES LONG HEX KEY SET



- ANSI B18.3.2M-1979 ,GGG-K-275D
- S2 steel
- HRC 60 +/- 2, increase 20% torque than Cr-V
- Fine satin finish

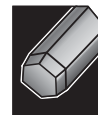

SKU	DESCRIPTION
STMT92619-8	1.5/2/2.5/3/4/5/5.5/6/8/10 mm

PIPE WRENCHES



- Jaw forged in Chrome Molybdenum steel
- Cast iron body

SKU	DESCRIPTION
87-620	140mm
87-621	170mm
87-622	250mm
87-623	300mm
87-624	320mm
87-625	450mm
87-626	550mm
87-627	800mm

1/2" IMPACT STANDARD SOCKET SET - 13 PIECES



SKU	DESCRIPTION
STMT73916-8	10, 11, 12, 13, 14, 15, 16, 17, 18, 19, 20; 21, 22, 23, 24 mm

1/2" IMPACT DEEP SOCKET SET - 13 PIECES



SKU	DESCRIPTION
STMT73917-8	1/2" Deep impact socket set (13pcs)

METAL CASE SOCKET SETS



PRECISION TORQUE DURABILITY

SKU	DESCRIPTION
STMT74183-8	24PCS 1/2" 6PT CONTENTS: 1/2" Pear head ratchet NP9 - 1/2" Extension 125, 250mm - 1/2" Universal joint 1/2" 6PT Spark plug socket 16mm - 1/2" 15" Swivel handle 1/2" 6PT Standard socket 8, 10, 11, 12, 13, 14, 15, 16, 17, 18, 19, 20, 21, 22, 24, 27, 30, 32 mm
STMT74184-8	24PCS 1/2" 12PT CONTENTS: 1/2" Pear head ratchet NP9 - 1/2" Extension 125, 250mm - 1/2" Universal joint 1/2" 12PT Spark plug socket 16mm - 1/2" 15" Swivel handle 1/2" 12PT Standard socket 8, 10, 11, 12, 13, 14, 15, 16, 17, 18, 19, 20, 21, 22, 24, 27, 30, 32 mm

Strong metal case



Chrome vanadium steel (Cr-V)

Ergonomic handle design reducing the risk of slippage

Extra torque for more powerful tightening

Chrome vanadium steel (Cr-V)



AIRTOOLS IMPACT - 3/8"

NEW
 2019 U.S. Patent # 10,153,711 B2
 2019 U.S. Patent # 10,153,711 B2



- 5 speeds forward and reverse
- Compact design for light torque applications
- Max Torque : 244 n-m (180 ft-lbs)
- Free Speed : 9.000 rpm
- Air Consumption : 3.1 cfm
- Hammering Mechanism : jumbo hammer
- Vibration : 3.0 m/s2
- Noise level :86.0 db under no load
- Housing: alum.
- Exhaust: handle
- Air Pressure : 90 psi
- Air Hose : 1/2"
- Air Inlet : 1/4"

3/8"DR.
244
 MAX TORQUE N.m



SKU	DESCRIPTION
STMT70116-8	3/8" - 244 N- m (180 ft- lbs)

AIRTOOLS IMPACT - 1/2"

NEW
 2019 U.S. Patent # 10,153,711 B2
 2019 U.S. Patent # 10,153,711 B2



- Patented hammer case improving durability
- 5 speeds forward and reverse
- Balanced weight design and handle exhaust directs air away
- Max. Torque: 610 N-m (450 ft-lbs)
- Free Speed: 7500 rpm
- Air Consumption: 3.9 cfm
- Hammering mechanism : twin hammer
- Vibration: 5.20 m/s2
- Noise level: 95 dB under no load
- Housing: Alum.
- Exhaust: Handle
- Air Pressure : 90 psi
- Air hose: 3/8"
- Air Inlet: 1/4"

1/2"DR.
610
 MAX TORQUE N.m

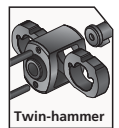

SKU	DESCRIPTION
STMT99300-8	1/2" - 610 N- m (450 ft- lbs)

AIRTOOLS IMPACT - 3/4"

NEW
 STANLEY
 AIRTOOLS
 IMPACT
 3/4" DR.
 1492 N.m
 3.600 RPM
 4.0 CFM



- High performance motor maximizes power output with full power in reverse; adjustable power in forward
- Balanced weight design and handle exhaust directs air away from the user
- Designed for fleet & truck service work
- Max. Torque: 1492 N-m (1.100 ft-lbs)
- Free Speed: 3.600 RPM
- Air Consumption: 4.0 CFM
- Rotator: Pin Clutch
- Vibration: 5.50 m/s²
- Noise level: 96.2 under no load
- Housing: Alum.
- Exhaust: Handle
- Air Pressure : 90 psi
- Air hose : 1/2 "
- Air Inlet : 1/4 "

3/4"DR.
1492
 MAX TORQUE N.m

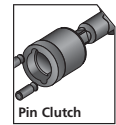

SKU	DESCRIPTION
STMT97134-8	3/4" - 1492 N- m (1.100 ft- lbs)

AIR RATCHET - 1/2"

NEW
 STANLEY
 AIRTOOLS
 RATCHET
 1/2" DR.
 81.4 N.m
 180 RPM
 3.9 CFM



- Double ratchet pawls increase durability and tool life
- Enlarged forward and reverse switch
- Comfort rubber grip
- EXHAUST: 360° adjustable exhaust directs air away from the user
- Max. Torque: 81.4 N-m (60 ft-lbs)
- Free Speed: 180 RPM
- Air Consumption: 3.9 CFM
- Rotator: Double Pawl
- Vibration: 3.73 m/s²
- Noise level: 88.50 dB under no load
- Air Pressure : 90 psi
- Air hose : 3/8 "
- Air Inlet : 1/4 "

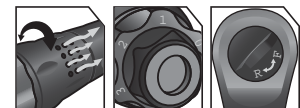

SKU	DESCRIPTION
STMT78056-8	1/2" - 81.4 N- m (60 ft- lbs)



“ HERE’S A SMALL TIP TO MAXIMIZE YOUR AIR TOOL’S ENDURANCE: SLATHER A TEASPOON OF COOKING OIL IN THE AIR INLET ONCE IN A WHILE. THIS ENSURES THE MECHANISM IS WELL LUBRICATED AND THE TORQUE OUTPUT REMAINS CONSISTENT. THERE IS ALWAYS MOISTURE FORMING IN THE AIR PIPELINES OF ALL WORKSHOP ”

TORQUE WRENCHES



- ISO 6789, ASME B107.14
- Accuracy: +/- 4%
- Visual and audible indication
- Dual Way direction(C.W./C.C.W.) Click Type
- Dual scales (N.m & IN.LB.)
- Quick release button
- Adjusting ring locking system
- Aluminum Alloy handle with anodic treatment
- Si-Cr-Mo spring
- Cr-Mo pawl
- Cr-Mo square driver
- 48 Gear teeth



SKU	DESCRIPTION	DRIVE SIZE	TORQUE RANGE		INCREMENT
STMT73587-8	1/4" - 5- 25 Nm	1/4"	5-25 Nm	48.7-225.7 IN.LB.	0.1 N.m
STMT73588-8	3/8" - 10- 50Nm	3/8"	10-50 Nm	9.2-38.7 FT.LB.	0.5 Nm
STMT73589-8	1/2" - 20- 100Nm	1/2"	20-100 Nm	16.6-75.6 FT.LB.	0.5 N.m
STMT73590-8	1/2" - 40- 200Nm	1/2"	40-200 Nm	33.2-151.2 FT.LB.	1 N.m
STMT73591-8	1/2" - 60- 340Nm	1/2"	60-340 Nm	51.6-258.1 FT.LB.	2 N.m
STMT73592-8	3/4" - 150- 750Nm	3/4"	150-750 Nm	110-550 FT.LB.	2.5 N.m

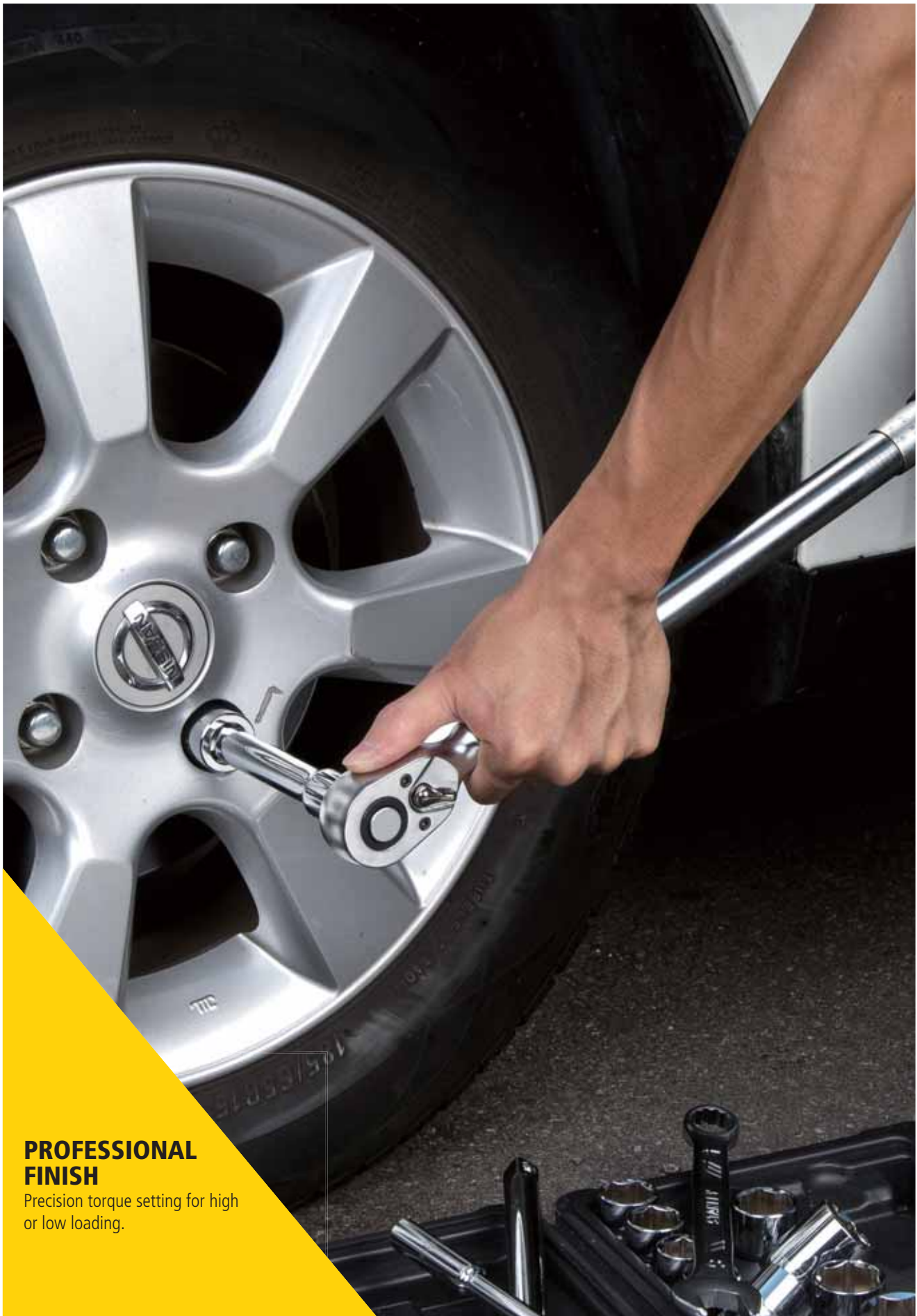

**PROFESSIONAL
FINISH**

Precision torque setting for high or low loading.

STANLEY®

STAPLING, RIVETING & GLUING



Staple Guns

Staples

Riveters

Glue Guns



STANLEY®

HEAVY-DUTY STAPLERS

Professional Contractors have relied on STANLEY® manual staplers since the 1970s and it's easy to understand why. These ruggedly built tools and staples are tough enough to survive dusty, dirty job sites and still provide enough power to drive staples into thick, dense wood - day in and day out, all day long.



STANLEY® HEAVY DUTY STAPLERS & BRAD NAILERS

HEAVY DUTY STAPLE GUN



- Lock down handle for easier storage
- Takes heavy duty staples



SKU	DESCRIPTION
6-TR150HL	Takes type G staples

6 IN 1 STAPLE GUN



- Hi Low Setting – for different types of material
- Staple Switch to adjust for appropriate staple use
- Includes small supply of each staple !



SKU	TYPE	DESCRIPTION
FMHT6-70868	LD/HD/Cable/Brads	6 in 1 Stapler / Brad Nailer

SHARP SHOOTER HEAVY DUTY



- Fires type G staples
- Lock down handle- for easy and compacy storage



SKU	TYPE	DESCRIPTION
6-TR110	Heavy duty	Fires type G staples

LIGHT DUTY STAPLE GUN



- Easy access staple insertion for fast loading
- Lock down handle for easier storage

SKU	DESCRIPTION
6-TR45	Use with type A staples

LIGHT DUTY STAPLES - TYPE A

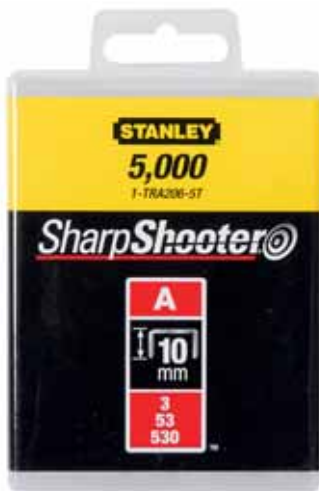

SKU	DESCRIPTION
1-TRA204T	6mm - 1000 pieces
1-TRA205T	8mm - 1000 pieces
1-TRA206T	10mm - 1000 pieces

HEAVY DUTY STAPLES - TYPE G



SKU	DESCRIPTION
1-TRA704T	6mm - 1000 pieces
1-TRA705T	8mm - 1000 pieces
1-TRA706T	10mm - 1000 pieces
1-TRA708T	12mm - 1000 pieces
1-TRA709T	14mm - 1000 pieces

RIVETERS

- Non-slip grip and wrench for changing nose pieces
- Spring loaded handle ejects rivets stem



69-799



69-646-22

SKU	DESCRIPTION
69-799	Heavy Duty Riveter
69-646-22	Medium Duty Riveter

DUALMELT PRO™ GLUE GUN KIT

- 2 x additional interchangeable nozzles
- 12 x Dual Temperature General Purpose glue sticks

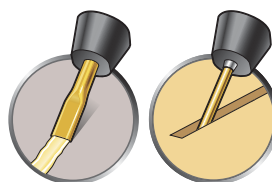

SKU	DESCRIPTION
0-GR100	80 watts gun - Takes dual melt 11.3mm glue sticks

TRIGGER FEED DUAL MELT GLUE GUN

- Heats up quickly and bonds within 60 seconds
- Uses standard dual- temperature glue on both settings and hot-melt formulas on high setting



SKU	DESCRIPTION
0-GR25	40 watts gun - Takes dual melt 11.3mm glue sticks

STANLEY®

TOOL STORAGE & DECORATION



Storage

Toolboxes

Metal Tool Box

Mobile Workshops

Tool Bag

Plastic Tool Boxes

Metal Tool Box



NEW

STANLEY®

19" METAL TOOLBOX

The **STANLEY®** 19" Metal Toolbox features a one-handed operation latch and release concept. There are 3 options available; no drawers, auto-slide drawer for simultaneous access, and 2 drawers as external ones for more compartmentalized storage.



**GOOD DESIGN
AWARD 2014**



**LONG
HANDLE**
Safe and secure

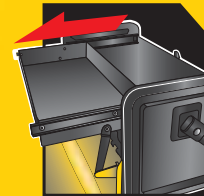

**AUTO SLIDING
DRAWER**
Ultra Flexibility



**ONE HAND
OPERATION**
Brings efficiency



**CENTRAL LOCK
MECHANISM**
Ultra Flexibility



METAL TOOLBOX

 **GOOD DESIGN
AWARD 2014**

NEW
STANLEY
19" Metal Toolbox
with 1 Drawer
STST73100-8
19" Metal Toolbox
with 2 Drawers
STST73101-8

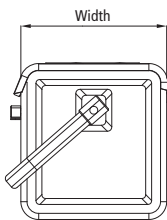
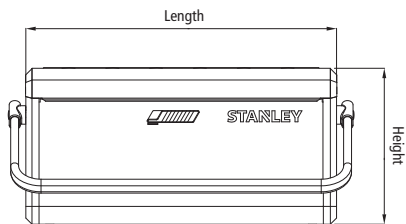

- One-handed operation
- Long handle



STST73099-8

- One-handed operation
- Long handle
- Auto sliding drawer



STST73100-8

- One-handed operation
- Long handle
- Central lock mechanism
- Ball bearing drawer slides



STST73101-8

SKU	DESCRIPTION
STST73099-8	19" Metal Toolbox - No Drawer
STST73100-8	19" Metal Toolbox - 1 Drawer
STST73101-8	19" Metal Toolbox - 2 Drawers

16" METAL CANTILEVER TOOLBOX

NEW

The **STANLEY®** 16" Metal Cantilever Toolbox is a one-of-a-kind storage solution for improved efficiency. The toolbox offers a duo layer design for simple organization and unique user-facing storage space for quick tool access.

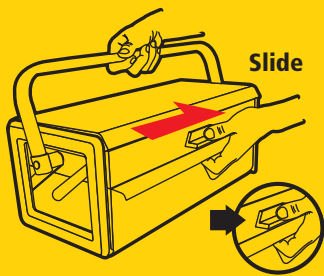

Long handle makes it easy to carry around and maneuver.

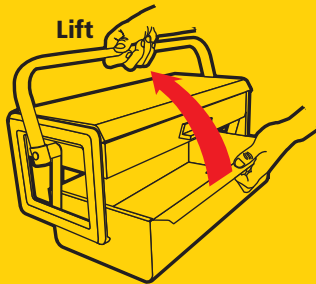

“ UTILIZE THE FULL TRAY SPACE AND STORE BULKIER TOOLS COMPARED TO OTHER SIMILAR SIZED CANTILEVER TOOLBOXES ”

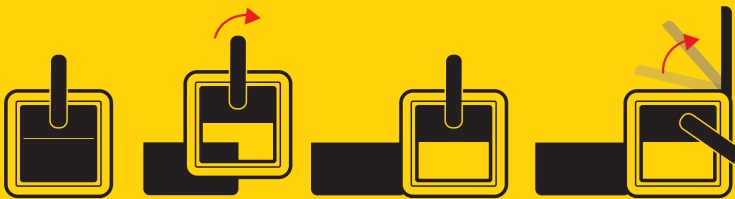

“ SMART BUMPER PROTECTS THE SIDE AND OFFERS SUPPORT BY SERVING AS A STAND ”

SKU	DESCRIPTION
STST73097-8	16" Metal Toolbox - Cantilever 2 Layers

6-DRAWER ROLLER CABINET



- 6 drawers: 3 - 60mm in height and 3 - 130mm in height
- Maximum load 800kg
- Centralised key locking system (2 keys included)
- Supplied without tools

SKU	DESCRIPTION
1-94-737	Dimensions 44 x 90 x 67,5 cm

4-DRAWER ROLLER CABINET



- Ball bearing slides
- ABS top tray
- Side folding shelf
- Lockable wheel with rubber caster

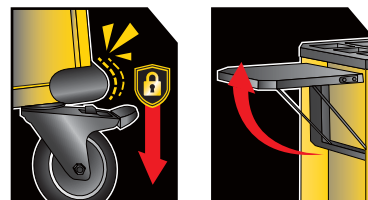

SKU	DESCRIPTION
STMT99069-8	Dimensions 698 x 477 x 973 mm



“ FEATURING ITS EXCELLENT MOBILITY, STANLEY STORAGE RANGE FULFILS THE REQUIREMENTS OF WORKSHOPS IN VARIOUS SIZES, REPRESENTING THE BEST DESIGN FOR HARD WORK. ”

5 TRAY METAL TOOL BOX



- 3 or 5 compartments
- 2 articulated handles for 100% access to compartments

SKU	DESCRIPTION
1-94-738	Easy access - Anti finger trap system - 21 x21 x 45 cms

FATMAX® MOBILE WORK STATION



- Opens up easily into a 4 level workstation
- Tool box with lift-out tray for smaller tools
- Large adjustable organiser for nails, screws and other small components

SKU	DESCRIPTION
1-94-210	Dim : 55 x 74 x 42 cm

MOBILE JOB CHEST™ WITH INTEGRATED LOCK



- Maximum storage and easy transportation for larger tools
- Extra large rust resistant metal latches,
- Wide telescopic steel handle with soft grip, suitable for use with gloved hands

SKU	DESCRIPTION
1-93-278	Big volume (190 L) , wide telescopic steel handle / Dim: 97 x 59 x 58 cm

28" STRUCTURAL FOAM TOOL BOX

MADE IN USA
WITH GLOBAL MATERIALS™



- Constructed of structural foam for extra strength
- Extra large storage capacity
- All round water seal ensures safe and dry storage

SKU	DESCRIPTION
028001L	Dim 71 x 30.8 x 28.5 cm

24" PLASTIC TOOL BOX

MADE IN USA
WITH GLOBAL MATERIALS™



- Professional strong plastic toolbox with metal latches
- Soft grip handle, greater comfort/better grip
- Storage tray for smaller items more frequently used

SKU	DESCRIPTION
0240135	Dim: 61 x 27 x 28 cm

BACKPACK TOOLBAG



- Tools back pack
- 600 x 600 denier fabric
- Detachable divider
- Padded back
- Separate compartment

BENEFITS:

- Easy transporting and storing tools leaves your hands free.
- Durable
- For frequently used tools
- For ergonomic, convenient carriage
- Keeps power tools and laptop safe



SKU	DESCRIPTION
STST515155	Backpack Toolbag

FATMAX® BACKPACK ON WHEELS



- Strong reinforced plastic base with wheels
- Large inner compartment
- Large storage divider.



SKU	DESCRIPTION
FMST514196	FatMax® Backpack on Wheels

18" FATMAX® TOOLBAG



- Shoulder strap – allows easier carrying of heavy loads
- Industrial leather reinforcements in critical points



SKU	DESCRIPTION
1-93-950	Dim 49 x 26 x 10 cm

STANLEY® 16" OPEN MOUTH TOOL BAG



- 600 denier fabric
- Hardwearing, strong & durable
- Multiple internal and external pockets
- Adjustable shoulder strap for easy carriage of tools



SKU	DESCRIPTION
STST516126	16" Open Mouth Bag

STANLEY® RIGID MULTIPURPOSE TOOL BAG 16"



- Heavy duty 600 denier fabric for long life
- Separate transparent document compartment
- Easy carriage of tools with an adjustable shoulder strap



SKU	DESCRIPTION
1-96-193	Dim : 44.7 x 26.2 x 25.1 cm

12" SOFT SIDE TOOL BAG



- Ideal for carrying hand tools
- Comfortable, cotton-padded handles
- Rubber foam bottom keeps bag sturdy



SKU	DESCRIPTION
STST512114	12" Soft Side Tool Bag

YELLOW & BLACK PLASTIC TOOLBOXES - ECON SERIES

MADE IN  TURKEY
WITH GLOBAL MATERIALS™

- Available in 13, 16, 19 and 22"
- Made in Turkey
- Competitive pricing



13"



16"



19"



22"

SKU	OLD SKU	DESCRIPTION
1-71-948	STST1-71948	13"
1-71-949	STST1-71949	16"
1-71-950	STST1-71950	19"
1-71-951	STST1-71951	22"

GLASS CUTTER - SCRAPERS



SKU	DESCRIPTION
0-14-040	Coming with 6 steel wheels, wooden handle

TOOL BAG STORAGE LINE



OPEN BULKY STRUCTURE DESIGN
Easy access to tools

600X600 DENIER FABRIC
Hardwearing, strong and durable

STRONG REINFORCED PLASTIC BASE
Protection from wet and damp surfaces

FREE STANDING OPEN MOUTH
Non collapsible enables easy access to tools at all times

MULTIPLE INTERNAL AND EXTERNAL POCKETS
Maximum organization potential

COVERED FRONT POCKET
Secure storage of small parts or personal items



PRACTICAL STORAGE SOLUTIONS

for professional workshops

STANLEY®

MIXED SETS



FIELDSETS

8 PIECES HAND TOOL MIXED SET



SKU	DESCRIPTION
70-877	6" universal plier, Standard Screwdriver, Phillips Screwdriver, 18mm snap off knife, 13oz fiberglass handle hammer, 6" adjustable wrench, 3m/10' tape measure

6 PIECES HAND TOOL MIXED SET



SKU	DESCRIPTION
70-881	13oz fiberglass handle hammer, 6" Universal Pliers, 6" Long Nose Pliers, 6x4" standard screwdriver, 2x4" phillips screwdriver, 18mm snap off knife.

5 PIECES HAND TOOL MIXED SET



SKU	DESCRIPTION
70-882	Ph#2 x 4" Bimaterial Screwdriver, ANSI ¼ x 4" Bimaterial Screwdriver, ANSI 3m/10' Tape Measure, 13oz fiberglass Handle Hammer, ANSI Universal Plier 7", ANSI Adjustable Wrench 8", ANSI.

5 PIECES HAND TOOL MIXED SET



SKU	DESCRIPTION
70-883	Ph#2 x 4" Bimaterial Screwdriver, ANSI ¼ x 4" Bimaterial Screwdriver, ANSI 3m/10' Tape Measure, 16oz fiberglass Handle Hammer, ANSI 18mm Plastic Snap- Off Knife

5 PIECES HAND TOOL MIXED SET



SKU	DESCRIPTION
70-884	Ph#2 x 4" Bimaterial Screwdriver, ANSI ¼ x 4" Bimaterial Screwdriver, ANSI 3m/10' Tape Measure, Long Nose Plier 6", ANSI Adjustable Wrench 6", ANSI

STANLEY®

INDEX

A L P H A

N U M E R I C

INDEX

ALPHA NUMERIC

SKU ---> Page

0-10-073 ---> P37
 0-10-280 ---> P36
 0-10-778 ---> P35
 0-11-921 ---> P35
 0-12-313 ---> P67
 0-12-315 ---> P67
 0-12-508 ---> P67
 0-14-040 ---> P128
 0-15-218 ---> P61
 0-15-842 ---> P61
 0-16-050 ---> P67
 0-16-128 ---> P69
 0-16-129 ---> P69
 0-16-130 ---> P69
 0-16-535 ---> P69
 0-16-537 ---> P69
 0-16-539 ---> P69
 0-16-540 ---> P69
 0-16-542 ---> P69
 0-16-545 ---> P69
 0-16-547 ---> P69
 0-16-548 ---> P69
 0-16-549 ---> P69
 0-16-551 ---> P69
 0-16-554 ---> P69
 0-16-558 ---> P69
 0-16-560 ---> P69
 0-16-870 ---> P68
 0-16-873 ---> P68
 0-16-877 ---> P68
 0-16-880 ---> P68
 0-16-881 ---> P68
 0-20-556 ---> P59
 0-28-500 ---> P38
 0-28-590 ---> P38
 0-33-231T ---> P11
 0-34-102 ---> P13
 0-34-105 ---> P13
 0-42-130 ---> P20
 0-42-294 ---> P20
 0-43-603 ---> P19
 0-43-609 ---> P19

SKU ---> Page

0-47-100 ---> P21
 0-47-316 ---> P22
 0-47-465 ---> P21
 0-47-973 ---> P22
 0-60-001 ---> P47
 0-60-002 ---> P47
 0-60-100 ---> P48
 0-60-220 ---> P48
 0-63-022 ---> P49
 0-65-007 ---> P45
 0-65-009 ---> P45
 0-65-011 ---> P45
 0-65-426 ---> P52
 0-65-428 ---> P52
 0-65-443 ---> P52
 0-66-357 ---> P49
 0-69-253 ---> P106
 0-69-256 ---> P106
 0-84-001 ---> P81
 0-84-002 ---> P81
 0-84-003 ---> P81
 0-84-004 ---> P81
 0-84-006 ---> P81
 0-84-007 ---> P81
 0-84-009 ---> P81
 0-84-010 ---> P81
 0-84-016 ---> P81
 0-84-054 ---> P83
 0-84-055 ---> P83
 0-84-056 ---> P83
 0-84-072 ---> P82
 0-84-075 ---> P83
 0-84-076 ---> P83
 0-84-077 ---> P82
 0-84-101 ---> P85
 0-84-102 ---> P85
 0-84-105 ---> P85
 0-84-108 ---> P85
 0-84-110 ---> P86
 0-84-111 ---> P86
 0-84-112 ---> P85
 0-84-113 ---> P85

SKU ---> Page

0-84-114 ---> P84
 0-84-294 ---> P81
 0-84-519 ---> P91
 0-84-622 ---> P83
 0-84-623 ---> P83
 0-84-625 ---> P83
 0-84-808 ---> P87
 0-84-809 ---> P87
 0-84-810 ---> P87
 0-84-811 ---> P87
 0-84-816 ---> P86
 0-95-112 ---> P30
 0-GR25 ---> P117
 0-GR100 ---> P117
 1-03-103 ---> P54
 1-11-300 ---> P37
 1-11-301 ---> P37
 1-11-921 ---> P35
 1-11-983 ---> P35
 1-12-003 ---> P65
 1-12-004 ---> P65
 1-12-005 ---> P65
 1-12-006 ---> P65
 1-12-020 ---> P66
 1-12-033 ---> P65
 1-12-034 ---> P65
 1-12-060 ---> P66
 1-12-078 ---> P65
 1-12-102 ---> P66
 1-12-116 ---> P66
 1-12-151 ---> P66
 1-12-152 ---> P66
 1-12-203 ---> P65
 1-12-204 ---> P65
 1-12-205 ---> P65
 1-12-220 ---> P66
 1-12-312 ---> P67
 1-12-313 ---> P67
 1-12-315 ---> P67
 1-15-122 ---> P60
 1-15-123 ---> P60
 1-15-140 ---> P60

SKU ---> Page

1-15-557 ---> P61
 1-15-558 ---> P61
 1-15-842 ---> P61
 1-17-387 ---> P98
 1-42-253 ---> P19
 1-42-254 ---> P19
 1-42-311 ---> P19
 1-42-312 ---> P19
 1-42-313 ---> P19
 1-42-314 ---> P19
 1-42-799 ---> P19
 1-45-686 ---> P17
 1-51-031 ---> P74
 1-51-033 ---> P74
 1-55-156 ---> P73
 1-55-157 ---> P73
 1-71-948 ---> P127
 1-71-949 ---> P127
 1-71-950 ---> P127
 1-71-951 ---> P127
 1-77-021 ---> P28
 1-77-160 ---> P30
 1-77-174 ---> P22
 1-77-176 ---> P22
 1-77-319 ---> P28
 1-77-320 ---> P28
 1-77-322 ---> P29
 1-83-067 ---> P79
 1-83-068 ---> P79
 1-86-789 ---> P103
 1-87-065 ---> P102
 1-87-371 ---> P98
 1-93-278 ---> P124
 1-93-950 ---> P126
 1-94-210 ---> P124
 1-94-658 ---> P102
 1-94-737 ---> P123
 1-94-738 ---> P124
 1-95-154 ---> P30
 1-95-770 ---> P97
 1-96-193 ---> P127
 1-TRA204T ---> P116

INDEX

ALPHA NUMERIC

SKU ---> Page

1-TRA205T ---> P116
 1-TRA206T ---> P116
 1-TRA704T ---> P116
 1-TRA705T ---> P116
 1-TRA706T ---> P116
 1-TRA708T ---> P116
 1-TRA709T ---> P116
 2-11-301 ---> P37
 2-14-562 ---> P79
 2-14-563 ---> P79
 2-14-564 ---> P79
 2-15-283 ---> P59
 2-15-594 ---> P59
 2-15-595 ---> P59
 2-15-599 ---> P59
 2-16-885 ---> P68
 2-34-777 ---> P13
 2-34-795 ---> P13
 2-46-028 ---> P17
 2-65-005 ---> P46
 2-84-181 ---> P88
 2-84-184 ---> P88
 2-85-582 ---> P102
 2-85-584 ---> P102
 4-69-262 ---> P105
 4-69-263 ---> P105
 4-84-485 ---> P82
 4-84-489 ---> P80
 4-87-054 ---> P97
 4-89-907 ---> P97
 5-21-103 ---> P68
 5-21-122 ---> P67
 5-21-293 ---> P68
 5-21-296 ---> P67
 5-21-393 ---> P68
 6-11-921 ---> P35
 6-97-043 ---> P82
 6-TR45 ---> P116
 6-TR110 ---> P115
 6-TR150HL ---> P115
 10-099 ---> P35
 14-164 ---> P89

SKU ---> Page

14-165 ---> P89
 14-166 ---> P89
 14-318 ---> P89
 14-324-23 ---> P89
 14-330 ---> P89
 14-336 ---> P89
 14-442 ---> P89
 45-600 ---> P17
 45-912 ---> P17
 54-192 ---> P73
 54-193 ---> P73
 60-060 ---> P47
 66-119 ---> P54
 66-120 ---> P54
 69-170 ---> P48
 69-172 ---> P48
 69-230 ---> P106
 69-646-22 ---> P117
 69-799 ---> P117
 70-877 ---> P132
 70-881 ---> P132
 70-882 ---> P132
 70-883 ---> P132
 70-884 ---> P132
 84-015 ---> P88
 84-167 ---> P83
 84-214 ---> P90
 84-223-22 ---> P90
 84-253 ---> P90
 84-270 ---> P83
 84-282 ---> P88
 84-629 ---> P89
 84-630 ---> P89
 84-632 ---> P89
 84-915 ---> P84
 84-916 ---> P84
 84-919 ---> P84
 86-477 ---> P102
 87-430-1-23 ---> P98
 87-620 ---> P106
 87-621 ---> P106
 87-622 ---> P106

SKU ---> Page

87-623 ---> P106
 87-624 ---> P106
 87-625 ---> P106
 87-626 ---> P106
 87-627 ---> P106
 93-020-22 ---> P90
 93-028 ---> P90
 94-806 ---> P90
 94-807 ---> P91
 97-797 ---> P98
 024013S ---> P125
 028001L ---> P125
 E-15200 ---> P60
 E-15470 ---> P59
 E-15471 ---> P59
 E-15472 ---> P59
 E-15473 ---> P59
 E-15558 ---> P59
 E-15559 ---> P59
 E-15560 ---> P59
 E-20206 ---> P60
 E-46530 ---> P17
 E-46532 ---> P17
 E-46534 ---> P17
 E-46536 ---> P17
 FMHT0-70767 ---> P30
 FMHT6-70868 ---> P115
 FMST514196 ---> P126
 STHT0-14102 ---> P80
 STHT0-14103 ---> P80
 STHT0-60017 ---> P47
 STHT0-70648 ---> P91
 STHT0-71028 ---> P92
 STHT0-71029 ---> P92
 STHT1-43110 ---> P18
 STHT1-43111 ---> P18
 STHT1-77032 ---> P28
 STHT1-77138 ---> P27
 STHT1-77139 ---> P27
 STHT1-77140 ---> P27
 STHT10150-8 ---> P36
 STHT10151-8 ---> P36

SKU -----> Page

STHT10189-8 ---> P37
 STHT10265-8 ---> P36
 STHT10265-8 ---> P36
 STHT10266-8 ---> P36
 STHT10266-8 ---> P36
 STHT10418-8 ---> P36
 STHT10425-8 ---> P36
 STHT11325-8 ---> P37
 STHT14556-8 ---> P80
 STHT14558-8 ---> P80
 STHT20807-8 ---> P61
 STHT30258-8 ---> P12
 STHT30259-8 ---> P12
 STHT30261-8 ---> P12
 STHT30265-8 ---> P12
 STHT30266-8 ---> P12
 STHT30656-8 ---> P12
 STHT30657-8 ---> P12
 STHT30686-8 ---> P12
 STHT30687-8 ---> P12
 STHT30696-8 ---> P12
 STHT30697-8 ---> P12
 STHT33158-8 ---> P11
 STHT33428-8 ---> P11
 STHT33463-8 ---> P11
 STHT34104-8 ---> P13
 STHT34107-8 ---> P13
 STHT34260-8 ---> P13
 STHT34262-8 ---> P13
 STHT34263-8 ---> P13
 STHT34297-8 ---> P13
 STHT34298-8 ---> P13
 STHT34791-8 ---> P13
 STHT34794-8 ---> P13
 STHT42465-8 ---> P20
 STHT43102-8 ---> P18
 STHT43103-8 ---> P18
 STHT43104-8 ---> P18
 STHT43105-8 ---> P18
 STHT43106-8 ---> P18
 STHT43107-8 ---> P18
 STHT43108-8 ---> P18

INDEX

ALPHA NUMERIC

SKU -----> Page

STHT43109-8 ---> P18
 STHT43118-8 ---> P18
 STHT43511-8 ---> P20
 STHT47403-8 ---> P22
 STHT47404-8 ---> P22
 STHT47440-8 ---> P21
 STHT47443-8 ---> P21
 STHT51071-8 ---> P74
 STHT51072-8 ---> P74
 STHT51081-8 ---> P74
 STHT51082-8 ---> P74
 STHT51271-8 ---> P74
 STHT51274-8 ---> P74
 STHT54189-8 ---> P73
 STHT54190-8 ---> P73
 STHT54191-8 ---> P73
 STHT57527-8 ---> P73
 STHT57528-8 ---> P73
 STHT62508-8 ---> P50
 STHT62511-8 ---> P50
 STHT65148-8 ---> P44
 STHT65149-8 ---> P44
 STHT65150-8 ---> P44
 STHT65151-8 ---> P44
 STHT65153-8 ---> P44
 STHT65154-8 ---> P44
 STHT65162-8 ---> P44
 STHT65163-8 ---> P44
 STHT65164-8 ---> P44
 STHT65165-8 ---> P44
 STHT65167-8 ---> P44
 STHT65169-8 ---> P44
 STHT65170-8 ---> P44
 STHT65171-8 ---> P44
 STHT65172-8 ---> P44
 STHT65173-8 ---> P44
 STHT65174-8 ---> P44
 STHT65180-8 ---> P43
 STHT65181-8 ---> P43
 STHT65182-8 ---> P43
 STHT65183-8 ---> P43
 STHT65186-8 ---> P43

SKU -----> Page

STHT65187-8 ---> P43
 STHT65188-8 ---> P43
 STHT65189-8 ---> P43
 STHT65193-8 ---> P43
 STHT65194-8 ---> P43
 STHT65195-8 ---> P43
 STHT65196-8 ---> P43
 STHT65197-8 ---> P43
 STHT65198-8 ---> P43
 STHT65980-8 ---> P51
 STHT66039-8 ---> P51
 STHT66052-8 ---> P51
 STHT68010-8 ---> P49
 STHT69121-8 ---> P53
 STHT69141-8 ---> P53
 STHT69145-8 ---> P53
 STHT69146-8 ---> P53
 STHT69147-8 ---> P53
 STHT69175-8 ---> P53
 STHT72678-8L ---> P50
 STHT72680-8L ---> P50
 STHT73055-8B ---> P53
 STHT73056-8B ---> P53
 STHT73057-8B ---> P53
 STHT73058-8B ---> P53
 STHT73069-8B ---> P54
 STHT73070-8B ---> P54
 STHT73071-8B ---> P54
 STHT84053-8 ---> P83
 STHT84271-8 ---> P86
 STHT84272-8 ---> P86
 STHT84273-8 ---> P86
 STHT84274-8 ---> P86
 STHT84369-8 ---> P87
 STHT84389-8 ---> P87
 STHT84398-8 ---> P88
 STHT92002-8 ---> P46
 STHT92004-8 ---> P46
 STMT33650-8 ---> P101
 STMT69213-8 ---> P106
 STMT70116-8 ---> P108
 STMT71648 ---> P103

SKU -----> Page

STMT71650 ---> P103
 STMT71651 ---> P103
 STMT71653 ---> P104
 STMT72794-8 ---> P104
 STMT72795-8 ---> P104
 STMT72803-8 ---> P99
 STMT72805-8 ---> P99
 STMT72807-8 ---> P99
 STMT72809-8 ---> P99
 STMT72810-8 ---> P99
 STMT72811-8 ---> P99
 STMT72812-8 ---> P99
 STMT72814-8 ---> P99
 STMT72816-8 ---> P99
 STMT72817-8 ---> P99
 STMT72818-8 ---> P99
 STMT72819-8 ---> P99
 STMT72821-8 ---> P99
 STMT72824-8B ---> P99
 STMT72827-8B ---> P99
 STMT72828-8B ---> P99
 STMT73587-8 ---> P110
 STMT73588-8 ---> P110
 STMT73589-8 ---> P110
 STMT73590-8 ---> P110
 STMT73591-8 ---> P110
 STMT73592-8 ---> P110
 STMT73647-8 ---> P100
 STMT73648-8 ---> P100
 STMT73649-8 ---> P100
 STMT73663-8 ---> P101
 STMT73664-8 ---> P101
 STMT73916-8 ---> P107
 STMT73917-8 ---> P107
 STMT74183-8 ---> P107
 STMT74184-8 ---> P107
 STMT78056-8 ---> P109
 STMT87431-8 ---> P98
 STMT87432-8 ---> P98
 STMT87433-8 ---> P98
 STMT87434-8 ---> P98
 STMT87435-8 ---> P98

SKU -----> Page

STMT89934-8B ---> P99
 STMT89936-8B ---> P99
 STMT89937-8B ---> P99
 STMT89938-8B ---> P99
 STMT89939-8B ---> P99
 STMT89940-8B ---> P99
 STMT89941-8B ---> P99
 STMT89944-8B ---> P99
 STMT92619-8 ---> P106
 STMT95893-8B ---> P105
 STMT95895-8B ---> P105
 STMT97134-8 ---> P109
 STMT99069-8 ---> P123
 STMT99300-8 ---> P108
 STST73097-8 ---> P122
 STST73099-8 ---> P121
 STST73100-8 ---> P121
 STST73101-8 ---> P121
 STST512114 ---> P127
 STST515155 ---> P125
 STST516126 ---> P126
 XTHT0-33503 ---> P11
 XTHT0-33504 ---> P11

STANLEY®

INDEX

**PRODUCT
DESCRIPTION**

ALPHABETICAL

INDEX

PRODUCT DESCRIPTION

ALPHABETICAL

PRODUCT DESCRIPTION -----> Page

B

BAILEY PLANES ---> P66
 BALL PEIN HAMMERS ---> P74
 BENCH VICES ---> P80
 BITS SETS ---> P51
 BLOCK PLANES ---> P67
 BOLT CUTTERS ---> P90

C

CABLE CUTTER ---> P90
 CHALK LINE ---> P22
 CHALK LINE AND PLUMB BOB ---> P22
 CHALK LINE SET ---> P22
 CHALK POWDER REFILL ---> P23
 CLASSIC BOX LEVELS ---> P19
 CLOSED CASE FIBERGLASS BLADE ---> P14
 CLOSED CASE STEEL BLADE ---> P14
 COMBINATION WRENCH SET ---> P101
 CRIMPING PLIERS ---> P91
 CROSS LINE LASERS ---> P29-P30
 CURVED JAW - LOCKING PLIERS ---> P88
 CUSHION GRIP SCREWDRIVERS ---> P44-P45
 CUSHION GRIP SETS ---> P46-P47

D

DOUBLE PINION HAND DRILL ---> P55

F

FOAM TOOL BOX ---> P126
 FOLDING UTILITY KNIFE ---> P38

G

GEAR WRENCHES ---> P100
 GLASS CUTTER - SCRAPERS ---> P129
 GLASS SCRAPER ---> P39
 GLUE GUN ---> P118
 GLUE GUN KIT ---> P118

H

HACKSAWS ---> P61-P62
 HACKSAW BLADES ---> P62
 HAMMERS ---> P74-P75
 HEADLAMP - FATMAX® ---> P31
 HEX KEYS ---> P106 / P107
 HEX KEY SETS ---> P107

PRODUCT DESCRIPTION -----> Page

J

JOB CHEST™ - MOBILE ---> P125

L

LEVELS ---> P19-P21
 LEVELS - MHL ---> P20
 LEVELS - TMLH ---> P20
 LEVELS - TORPEDO ---> P20-P21
 LOCKING PLIERS ---> P87-P89
 LONG NOSE - LOCKING PLIERS ---> P88
 LONG TAPES ---> P14

M

MIXED SETS ---> P133
 MOBILE JOB CHEST™ ---> P125
 MOBILE WORK STATION ---> P125
 MULTI TOOLS ---> P91-P92
 MULTI TOOLS SET ---> P93

N

NAIL-PULLING HAMMERS ---> P75

O

ODOMETER ---> P23
 OPEN CASE FIBERGLASS BLADE ---> P14
 OPTICAL LEVEL ---> P31

P

PERMANENT MARKER ---> P23
 PINCERS ---> P89
 PIPE WRENCHES ---> P107
 PLANES - BAILEY ---> P66
 PLANES ---> P66 - P67
 PLANES IRONS ---> P68
 PLASTIC TOOL BOX ---> P126
 PLIER SET - VDE ---> P81
 PLIER SETS - BIMATERIAL ---> P83
 PLIERS ---> P82-P87
 PLIERS - BIMATERIAL ---> P84
 PLIERS - LOCKING ---> P87-P88
 PLIERS - VDE ---> P82
 PLUMB BOB ---> P23
 POCKET LEVEL ---> P21
 POWERLOCK TAPES ---> P12
 PRECISION SCREWDRIVER SETS ---> P52

INDEX

PRODUCT DESCRIPTION

ALPHABETICAL

PRODUCT DESCRIPTION -----> Page

P

PVC HANDLE - SCREWDRIVERS ---> P54-P55
PVC PIPE CUTTER ---> P90

R

RATCHET SPANNERS ---> P98
REBATE PLANE ---> P66
RETRACTABLE BLADE KNIVES ---> P36
RIPPING BARS ---> P74
RIVETERS ---> P118
ROLLER CABINET ---> P124

S

SCREWDRIVERS ---> P44-P45; P54-P55
SCREWDRIVERS - BIT SETS ---> P51
SCREWDRIVERS - CUSHION GRIP 3 ---> P44-P45
SCREWDRIVERS - PVC HANDLE ---> P54-P55
SCREWDRIVERS - SPARK DETECTING ---> P55
SCREWDRIVERS - THRIFTY ---> P48
SCREWDRIVER SETS ---> P46-P54
SCREWDRIVER SETS - FATMAX® ---> P53
SCREWDRIVER SETS - PRECISION ---> P52
SCREWDRIVER SETS - RATCHETING ---> P50
SCREWDRIVER SETS - STUBBY ---> P50
SCREWDRIVER SETS - VDE ---> P52-P53
SHARPENING SYSTEM ---> P68
SHEARS & SCISSORS ---> P81
SHORT TAPES ---> P12-P13
SNAP OFF BLADES ---> P38
SNAP OFF KNIVES ---> P37
SNIPS ---> P80
SOCKET SETS ---> P103-P015
SOCKET WRENCHES ---> P99
SPANNERS - COMBINATION ---> P98
SPANNERS - OPEN ENDED ---> P98
SPARK DETECTING SCREWDRIVER ---> P55
SPECIALIST SAWS ---> P60-P61
SPOT LASER ---> P29
SPRINGBACK KNIFE ---> P38
SQUARES ---> P18
STAPLE GUN ---> P116 -P117
STAPLES ---> P117

PRODUCT DESCRIPTION -----> Page

STRAIGHT JAW - LOCKING PLIERS ---> P88
STUBBY SCREWDRIVER SET ---> P50
SURFORMS ---> P68-P69

T

THRIFTY - SCREWDRIVERS ---> P48
THRIFTY SCREWDRIVERS SETS ---> P48-P49
TIN SNIPS ---> P81;P90
TOOL BAG ---> P126-P128
TOOL BOX ---> P125;P128
TORCH RECHARGEABLE ---> P31
TORCH TRIPOD ---> P31
TRIMMING KNIFE BLADE ---> P36
TRUE LASER MEASUREMENT ---> P28
TUBING CUTTERS ---> P91
TYLON™ TAPES ---> P13

U

UTILITY KNIFE ---> P38

V

VDE PLIERS ---> P82
VDE SCREWDRIVER SETS ---> P52-P53

W

WATER PUMP - LOCKING PLIERS ---> P89
WINDOW SCRAPER ---> P39
WIRE STRIPPERS ---> P91
WOOD CHISELS ---> P69-P70
WOOD SAWS ---> P60-P61
WORK STATION - MOBILE ---> P125
WRENCHES ---> P99
WRENCH SET - COMBINATION ---> P100-P102
WRENCH SET - DOUBLE OPEN END ---> P102
WRENCH SET - DOUBLE RING ---> P102

NOTES

A series of horizontal dashed lines for writing notes.



STANLEY

STANLEY
WHITE SERIES
5m
METRIC
BODY CASE

STANLEY

STANLEY
3651 / 20"
STAINLESS

STANLEY®

All rights reserved. Neither this catalogue nor its text, illustrations, drawings or any part thereof, may be reproduced, stored in a retrieval system, photocopied, recorded or transmitted in any form, whether electronic or otherwise, without (our/Stanley Black & Decker) consent. All descriptions and illustrations contained in this catalogue are correct at the time of going to print. We cannot, however, be held liable for any inaccuracies of description or illustration and reserve the right to change specifications without notification.

© Stanley Works 2015/16.

E-mail : mea@stanleyworks.com

Website : www.stanleytools.com

Authorized Distributor

STHT7-97136